

INNOVATIVE TECHNOLOGIES :

Surface-mount / press-fit / low intermodulation / lock-on coupling system

► **MICROMINIATURE**

SBMO : 50 Ω ,snap-on blind mate series (DC - 40 GHz)

MMS/MC card /MMT : 50 Ω ,snap-on, SMT series

RF switch

COAXIPACK : metric system 2mm & DIN 41626

SSMA : 50 Ω , screw-on

SSMB : 50 Ω , snap-on

SBMA : 50 Ω , blind mate

Custom models can be developed according to your specifications

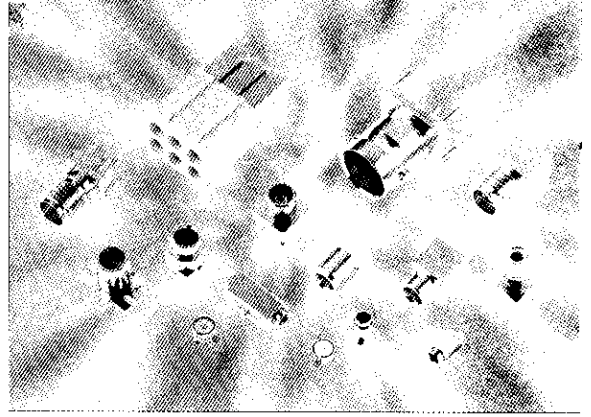

► **MINIATURE**

MCX : 50 and 75 Ω , snap-on

SMA : 50 Ω , screw-on, slide-on, standard and commercial

SMA 2.9 : 50 Ω , screw-on (DC - 40 GHz)

SMB, SMB LOCK, SMB CARLOCK : 50 Ω , snap-on

SMC : 50 Ω , screw-on

SMZ : 75 Ω , snap-on, lock-on, type BT43 series

BMA : 50 Ω , blind mate, standard and commercial

DIN 1.0/2.3 : 50 and 75 Ω , screw-on, snap-on and slide-on, lock-on models

FME : easy-connect cabling system

► **BETWEEN-SERIES ADAPTORS**

More than 95 combinations of different interfaces 50 Ω and 75 Ω

Custom packaging can be adapted to the exact customer needs

► **STANDARD**

DT-F : 75 Ω , screw-on

BNC : 50 and 75 Ω , bayonet system, standard and commercial

TNC/TNC 18 : 50 and 75 Ω , screw-on, standard and commercial

DIN 1.6/5.6 : 75 Ω , screw-on, snap-on and slide-on

N/N 18 : 50 and 75 Ω , screw-on, standard and commercial, low intermodulation models, slide-on models

DIN 7/16 : 50 Ω , screw-on, low intermodulation

Other series : HN - UHF - C - LC

► **SPECIAL and HIGH VOLTAGE**

miniQUICK : 50 and 75 Ω , push-pull system, slide-on models

BNC TRX / N TRX : triax series

BNC HT/SHV : bayonet system, 10 KV-10 A

miniQUICK HT : push-pull system, 12 KV-10 A

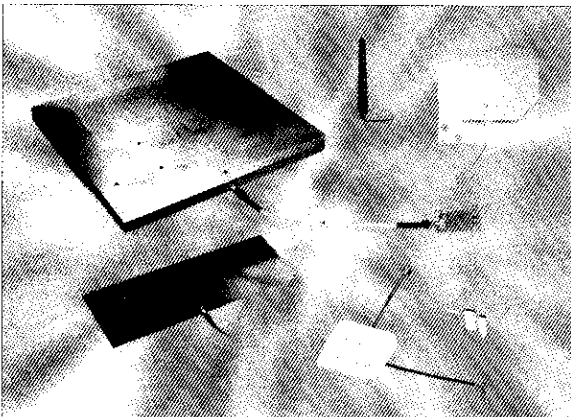
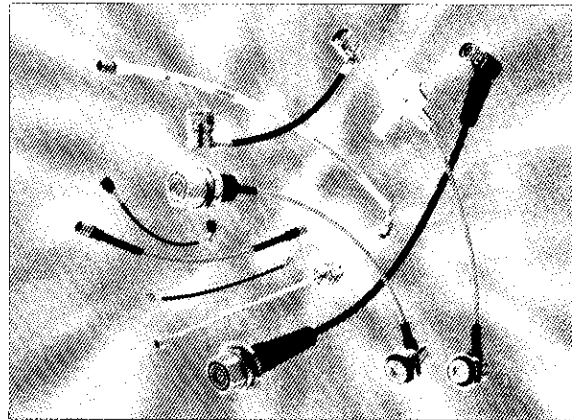

► **COAXIAL CABLE ASSEMBLIES & PIGTAILS**

RG cables ass. : standard and special cables : DC - 18 GHz

Option to RG cables ass. (halogen free, flame retardant)

SHF cable ass. : ultra low loss flexible cables : DC - 40 GHz

Corrugated cable assemblies (IMP) : -125 dBm

Semi-rigid and conformable cables : DC - 46 GHz

Custom design products (harness)

► **ANTENNAS**

Omnidirectional wire patch antenna

Patch array antenna (new dielectric material)

Patch ceramic or metallic antenna

Printed or wire dipole antenna

Dual polarization antenna

Dual band antenna

Embedded or external antenna

► **ACCESSORIES AND ASSEMBLY TOOLING**

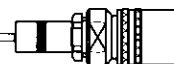

	Page
RADIALl company profile	4-5
Introduction	6
Product overview	7-9
User information	10-11
Technical characteristics	12
Interface	13-14
Standard Type 43	
Straight plug, full crimp type, snap DDF mount (single piece body)	15
Straight plug, full crimp type, bulkhead DDF mount (multi piece body)	15
Straight plug, full crimp type, snap DDF mount (multi piece body)	16
Straight plug, full crimp type, bulkhead DDF mount (multi piece body)	16
Straight socket, full crimp type (single piece body)	17
Straight socket, full crimp type (multi piece body)	17
Right angle socket, solder/crimp type	18
U-link	18
U-link with test port	19
Straight PCB mount plug	19
Right-angle PCB mount plug	20
HDC Type 43	
Straight plug, full crimp type, snap DDF mount (single piece body)	21
Straight plug, full crimp type, snap DDF mount (multi piece body)	21
Straight socket, full crimp type (single piece body)	22
Straight socket, full crimp type (multi piece body)	22
U-link	23
U-link, with test port	23
UHDC Type 43	
Straight plug, full crimp type, snap DDF mount (single piece body)	24
Straight socket, full crimp type (single piece body)	24
U-link	25
U-link with test port	25
BNC Type 31 (75 Ω)	
Straight plug, full crimp type	26
Right-angle plug, solder crimp type	26
Straight jack, full crimp type, bulkhead panel mount	27
Type 43/BNC Adapter	27
SMB FOR 75 Ω TELECOM CABLES	
Right-angle plug, solder crimp type	28
Application tooling	29
Panel and PCB mounting information	30
Assembly instructions	31-36
Telecommunications industry, Definition and glossary of terms	37-39
Type 43 - cross reference guide	40-41
Index of Part-Numbers	42

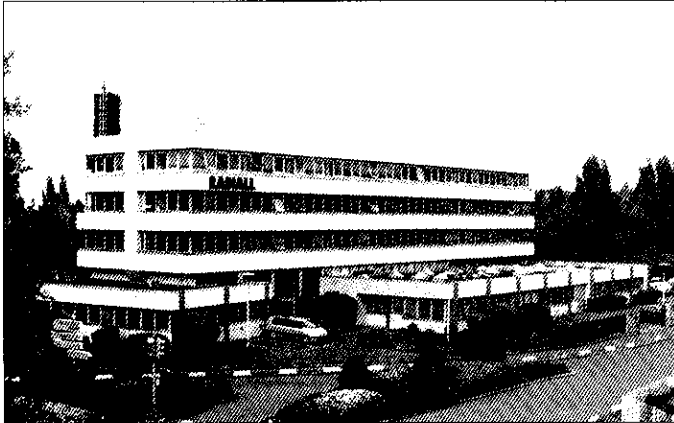
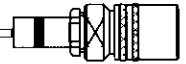

Head Office - Rosny sous Bois

Since 1952, **RADIALL** has specialized in the field of coaxial connectors and cables assemblies. **RADIALL's** experience and high technology focus, combined with our large worldwide production capability have made the company a major supplier of RF coaxial connectors in the world and the number one in Europe.

RESEARCH & DEVELOPMENT

The ever increasing sophistication of microwave communication systems is continually requiring components to meet a higher level of performance. **RADIALL's** research and development groups understand these needs and are committed to searching for product solutions that will be needed in the future. They also are providing continued improvements to our already extensive lines of high performance products. All our engineer teams are equipped with state of the art equipment and facilities, in an effort to provide the best solutions to our customers.



CAD workstation



Screw-machining shop

MANUFACTURING

RADIALL knows that the quality of the connectors components is directly related to the mechanical precision of the machining process, along with good quality procedures. In an effort to continually meet the highest quality standards, all our production plants are equipped with the latest state of the art production equipment. **RADIALL's** manufacturing process maintains strict control of all procedures and incorporates all tooling, machining, surface treatment and assembly operations into the manufacturing process of each production group.

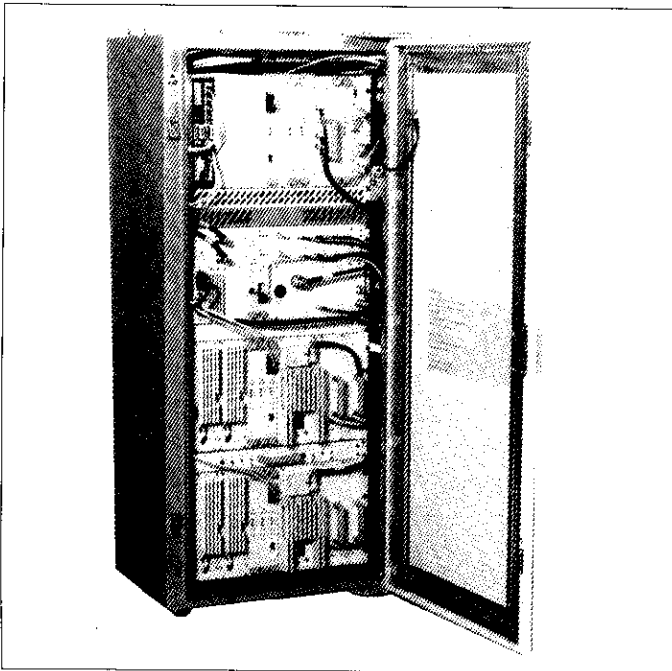
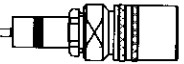

Base station of cellular network

HIGH RELIABILITY

Reliability of inter-connection systems is of the utmost importance in telecommunications applications. This industry need has led **RADIALL** to link high performance design, manufacturing and quality control. This has given the company the capability to produce connectors that will operate in the most stringent environments. The wide range of our product offering allows us to propose the best complete solution for your exact need.

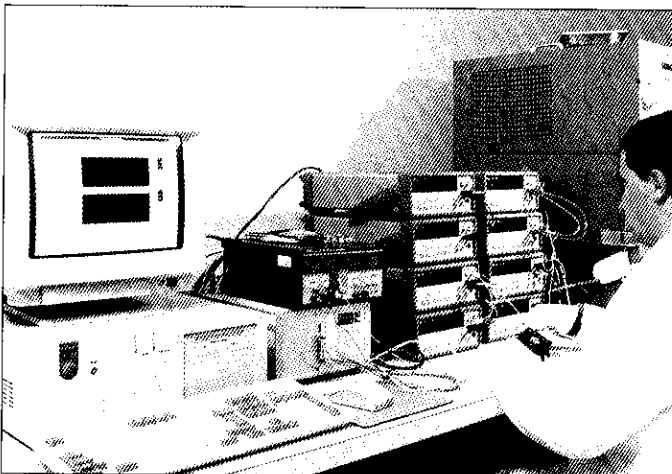

Microwave test device

QUALITY ASSURANCE

RADIALL, as a TQM company, continually searches for improvements to the quality process. We operate a Quality Assurance Program that has been developed in accordance with the national and **CECC** agencies (equivalent to **MIL-I-45208** and **MIL-C-45662** standards). This program has enabled us to achieve QPL approval on several of our connector series. **RADIALL's** Quality Assurance Program operates at all levels of manufacturing from the initial raw incoming material to the final testing procedures just prior to shipping. All test equipment is part of the quality process and is continually inspected on a regular scheduled basis. All production plants in Europe are **AQA P4-NATO** certified.



ISO 9001 ACCREDITATION

This certificate is witness to **RADIALL's** achievement and commitment to the Total Quality Process. **RADIALL** has always been, since its inception, a company committed to being a Total Quality supplier. Quality is our way of life at **RADIALL**.

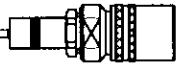

The Radiall Type 43 coaxial connector range

The Radiall range of Type 43 series connectors is fully approved (where applicable) to BT (British Telecom) standards as well as to British Standard BS9210 F0022.

The coaxial connector ranges featured in this catalogue include both the standard (12.7mm), high density (10.0mm) and ultra high density (9.00mm) versions of Type 43 Digital Distribution Frame (DDF) plugs, sockets and U-links, as well as ancillary products such as SMB, SMZ, BNC connectors and adaptors.

Typical product applications include, telecommunications switching equip-

ment including multiplexers, gateway and system/network monitoring equipment.

A wide range of additional interconnection products are also featured, which are designed to support all types of network installations requiring high quality voice and video transmissions.

Details of the complete range of Type 43 application tooling to allow fast and efficient on site termination of all products is also covered along with detailed connector termination and assembly instructions.

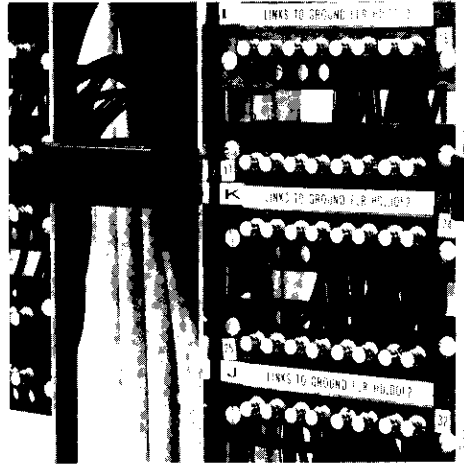

Type 43 series - Features and benefits

Proven design

Where applicable the Type 43 product range is approved to all current BT specifications, as well as being the first choice for many other new or existing analogue or digital telecommunication systems e.g. land based, mobile, PCN and GSM networks.

Low cost

Low installation cost due to high quality, proven crimp centre contact design.

High performance

Excellent VSWR at rated frequencies up to 3 GHz, typical values : *Straight style connectors* : max. 1.20
Right angle style connectors : max. 1.25.

Reliable

Long life design, incorporating special locking feature which prevents accidental disconnection.

Wide choice

Wide product range suitable for fixed DDF, cable mounted and system test applications.

Fast termination

Single piece body styles allow reliable, easy operator assembly in varied on-site conditions, full application tooling available.

Worldwide supply

All products available through Radiall's worldwide network of subsidiary offices and sales agents.

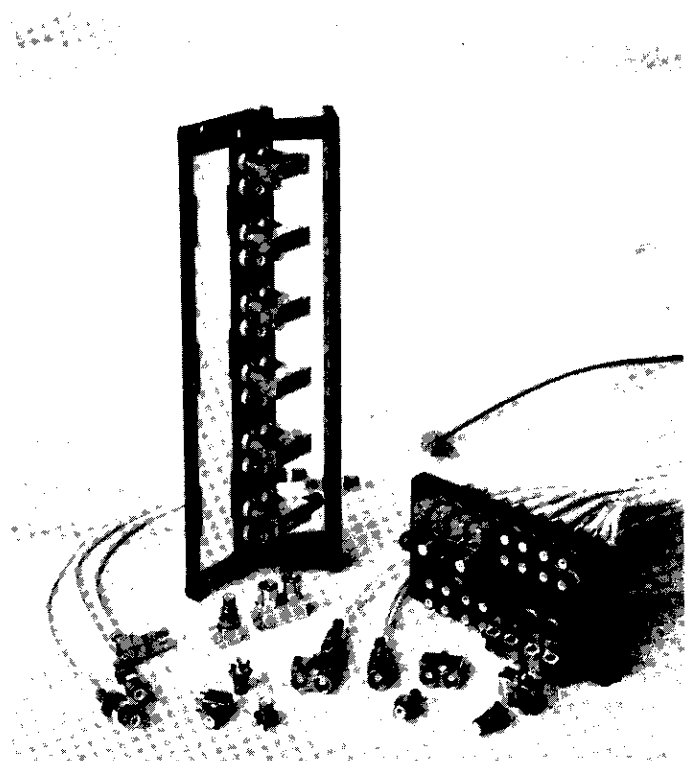

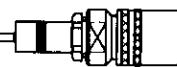

Standard Type 43 series Straight cable connectors



The complete range of standard Type 43, 75 ohm series connectors shown is, where applicable, fully approved to British Standard - BS9210 F0022.

The Type 43 interconnect system provides front or rear jumpered cable management solutions for Digital Distribution Frames (DDF) which meet the requirements of traditional telecommunication network operators.

Precision manufactured components with selective gold plating ensure both high quality and high performance from an industry proven coaxial connector system.

As part of the Transradio commitment to ongoing development of the Type 43 connector system a range of single piece Type 43 plug (GTIS) and socket (FS) connectors are featured in this catalogue.

These connectors feature main bodies which are of single piece construction which allow quick and simple cable termination.

The range featured includes a wide selection of connector body styles and is designed to suit all standard telecom cable types as well as RG179 and RD179 cable types.

Right Angle Cable Mount Sockets



Type 43 series, right angle, 75 ohm sockets are available for use with all designated telecom cable types as well as RG179 cables.

Each socket features the simple latching mechanism which ensures against accidental disconnection by a pull on the cable or connector body.

U - links



The Type 43 standard U-link is designed to link adjacent pairs of connectors horizontally or vertically on the DDF mounting block.

The U-link contacts are on 12.7mm centres and are selectively gold plated for optimum performance.

To allow easy testing or continuous circuit monitoring the U-link with test port is also available (signal level -30dB).



PCB mount plugs

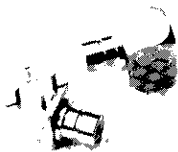

Printed circuit board mounting Type 43 plugs are available in both straight and right angle variants.

Contacts are selectively plated for high reliability and performance. These Type 43 plugs are compatible with standard HDC and UHDC derivative sockets.

The Type 43 straight mount PCB plug is also available in press-fit form. This product is available with compliant solderless pins for fast and reliable termination to the printed circuit board.

A complete range of press-fit termination tooling is available for both insertion and repair to support this product application.

HDC Type 43 series Coaxial connectors

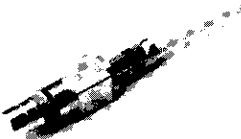

The Type 43 HDC derivative connector range is designed to suit Digital Distribution Frame (DDF) telecommunication applications.

The Type 43 HDC interconnect system provides a rear jumpered cable management solution which meets the requirements of not just traditional telecom operators but also that of CATV and mobile telecommunications networks.

Precision machined components with selective gold plating ensure both high quality and high performance from a proven coaxial connector system.

The Type 43 HDC series is fully intermateable with type 43 "standard" series connectors.

The single piece HDC DDF plug (HDC GTIS) provides fast "on site" termination and is easily fitted into the DDF mounting block by means of a simple latching grommet.

The single piece HDC Type 43 socket (HDC FS) is available in straight cable mounted versions.

A simple latching sleeve mechanism (fitted to the socket) ensures the socket cannot be accidentally disengaged from the plug when mated.

The socket connector is of single piece construction and is easily terminated using the application tooling as specified.

U - links

The Type 43 HDC "U" link is designed to link adjacent pairs of connectors horizontally or vertically on the DDF mounting block.

The "U" link contacts are on 10mm centres and are selectively gold plated for optimum performance.

To allow easy testing or continuous circuit monitoring a U-link with test port is also available (signal level -30dB).

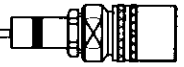

UHDC Type 43 series

Coaxial connectors

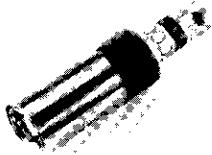

UHDC series is a system designed for a 9 mm mounting pitch on the digital distribution frame and its application is for small condensed or mobile switching installations.

The product range consists of 4 connector styles

- 1) Straight female crimp/crimp latching socket cable mounting for TZC or BT3002 cable (3.6/75 double screen) UHDC S43/5 FS with a new rear release latching mechanism.
- 2) Straight male crimp/crimp DDF plug for same cable as (1) UHDC P43/5GTIS.
- 3) Link UHDC 43/9A.
- 4) Link UHDC 43/9 B (with -30dB test access).

Additional telecommunications - support Interconnect products

BNC series connectors for telecom cables & applications (Type 31 series)



This range of full crimp termination BNC plugs and jacks is designed to fit standard telecommunications cables of 75 ohm impedance.

These high quality connectors feature nickel plated, machined bodies and coupling nuts and gold plated centre contacts.

All the telecom BNC connectors featured in this catalogue can be easily crimp terminated using the hexagonal cavity die sets contained in the Radiall Type 43 application tool kit.

SMB series connectors for switch/multiplex applications

SMB series connectors for telecom cables & applications (Type 31 series)



Standard SMB series connectors are available to allow interfacing with various other manufacturers telecommunications equipment/systems.

The SMB series plug connectors are of right angle and straight designs and both feature a "push-pull" snap on coupling mechanism and gold plated contacts for high performance and reliability.

This family of SMB connectors is designed to suit a range of telecom 75 ohm coaxial cables typically - RG179, BT3002 and TZC75024.



Standard Type 43 versus HDC 43 versus UHDC 43 series

Type 43 connectors are divided into two specific types, namely standard and high density versions (HDC).

The standard Type 43 connector version is designed for Digital Distribution Frames (DDF) with a 12.7mm spacing between the mounting holes (centre line to centre line).

HDC 43 connectors are designed for use in DDF's with a 10.0mm spacing between the mounting holes (centre line to centre line).

The UHDC 43 System is designed for use in DDF's where the connector mounting holes are on a 9.00mm pitch (centre line to centre line)

The Type 43 high density and ultra high density connector systems offer significant space saving over the standard connector range.

Type 43, HDC 43 and UHDC43 43 Generic Description and Part Numbers

Type 43 series connectors can be classified by the following generic telecom industry applications or descriptions:

Application or Description	Typical Connector Description Suffix
Digital distribution frame (DDF) "fixed" plugs	G, GTI & GTIS (single piece connector)
Cable mounted "free" sockets	F, FS (single piece connector)
DDF "U" links with and without test ports	9A, 9B (UHDC), 10A, 10B (HDC) and 13A, 13B (STD)
Right angle cable mounting "free" sockets	C
PCB mounting plugs, straight and right angle	1E & 1D

The suffix's as shown in the table above allow a fast easy reference to enable the user to determine the connectors application.

How a Type 43 part number is constructed

Example of how a Type 43 part number is constructed:

Example 1

P43/5 GTIS

P43 - denotes plug (P) connector type 43 series standard version for 12.7mm pitch DDF block

5 - denotes cable type, where (5) = BT3002 / TZC 75024

Additional numbers for classifying cable groups are as follows:

Cable Group	P/N Numeric Code
BT2001	1 - e.g. P43/1GTIS
BT2002	2 - e.g. S43/2FS
BT2003	3 - e.g. HDPC43/3GTIS
BT3002/TZC75024	5 - e.g. HDCS43/5GTIS
RG179	4 - e.g. HDCS43/4FS

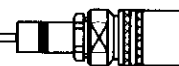

Example 2

HDCP43/5 GTIS

HDCP43 - denotes plug (P) connector type 43 series, high density version for 10.0mm pitch DDF block

5 - denotes cable type, where (5) = BT3002 / TZC 75024

GTIS - denotes single piece connector, full crimp design for "fixed" DDF applications

Cable type identification

In order to allow the user to visually identify a particular connector type when connectors are installed in a Digital Distribution Frame (DDF) each connector crimp sleeve is colour coded.

Different colours either **Green, Blue, Red and Black** are used to denote different cable types.

In the case of connectors for **RG179** and **RD179** the connector crimp sleeve has **no colour coding** only a plain finish.

For further details please see the table below:

Cable Designation	Colour Code	Basic Cable Details
BT2001	Green	4.4/75/S
BT2002	Blue	5.1/75/D
BT2003	Red	6.7/75/D
BT3002/TZC75024	Black	3.6/75/D
RG179	No colour code	2.6/75/S
RD179	No colour code	3.0/75/D

Type 43 series - EMC screening effectiveness

Due to the nature of its application and questions arising from EU EMC directives, as to the type 43 series EMC screening effectiveness, Radiall has now commissioned a series of tests to provide accurate information on this subject.

Using a BT2002 cable (terminated to a mated pair - Type 43 plug and socket) operating in a frequency range of 500 MHz to 2.4 GHz.

A brief summary of the test results ** are as follows : Using BT 2002 cable the type 43 series has a screening effectiveness of 70 dB at 1 GHz*.

Using a superscreened cable results were obtained of - 90 dB at 1 GHz*.

During testing it has been determined that any emissions occur from the cable and not from the mated connectors.

Note :

*Test method used is reverberant chamber method.

** A detailed test report is available on request, please contact your local Radiall representative for further details.

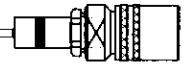

Type 43 general technical specification

SPECIFICATIONS

Radiall 75 Ω coaxial Type 43 connectors are designed to meet or exceed the requirements of BS9210 F0022. The following information is subject to change without notice. The performance values shown are typical and may not relate to all connector styles available.

TYPICAL CONNECTOR CONSTRUCTION

Connector Parts	Materials	Plating Finish
Body Components*	Brass	Selective Gold
Outer Contacts	Bronze	Selective Gold
Centre Contacts (male)	Brass	Gold
Centre Contacts (female)	Beryllium Copper	Gold
Insulator	PTFE	Not applicable
Panel Grommet	Polyacetal	Not applicable
Ferrule	Brass	Nickel
Panel Mounting Hardware**	Brass or Phosphor Bronze	Nickel

* In general all Type 43 series connector bodies are gold plated in mating areas.

As a note the single piece Type 43 connector body is gold plated in the mating area with other surfaces being nickel coated. All multi-piece connector bodies comprise of a gold plated front body (mating area) and a nickel plated back body (crimp area).

** Panel mounting hardware includes components such as - nut, washer, spacer etc.

ELECTRICAL PERFORMANCE

Electrical Characteristics	Typical Values
Nominal Impedance	75 Ω
Frequency Range	DC - 3 GHz
Temperature Range	- 40 to + 100 °C
VSWR (Straight Connectors)	1.20 max.
VSWR (Right Angle Connectors)	1.25 max.
Voltage Rating	500 Vrms max.
Dielectric Withstanding Voltage	1500 Vrms min.
Insulation Resistance	5000 MΩ min.

MECHANICAL PERFORMANCE

Mechanical Characteristics	Typical Values
Mechanical endurance	250 matings
Cable Retention (Plug Connectors)	60 to 220 N min.***
Cable Retention (Socket Connectors)	60 to 220 N min.***
Centre Contact Retention (Plug Connectors)	22 N min.
Centre Contact Retention (Socket Connectors)	22 N min.
Weight	10 g (grams) typical

*** Note, **lower cable retention value** for RG179 - 60 N min and BT3002/TZC 75024 - 150 N min.

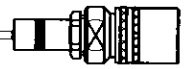

PLUG

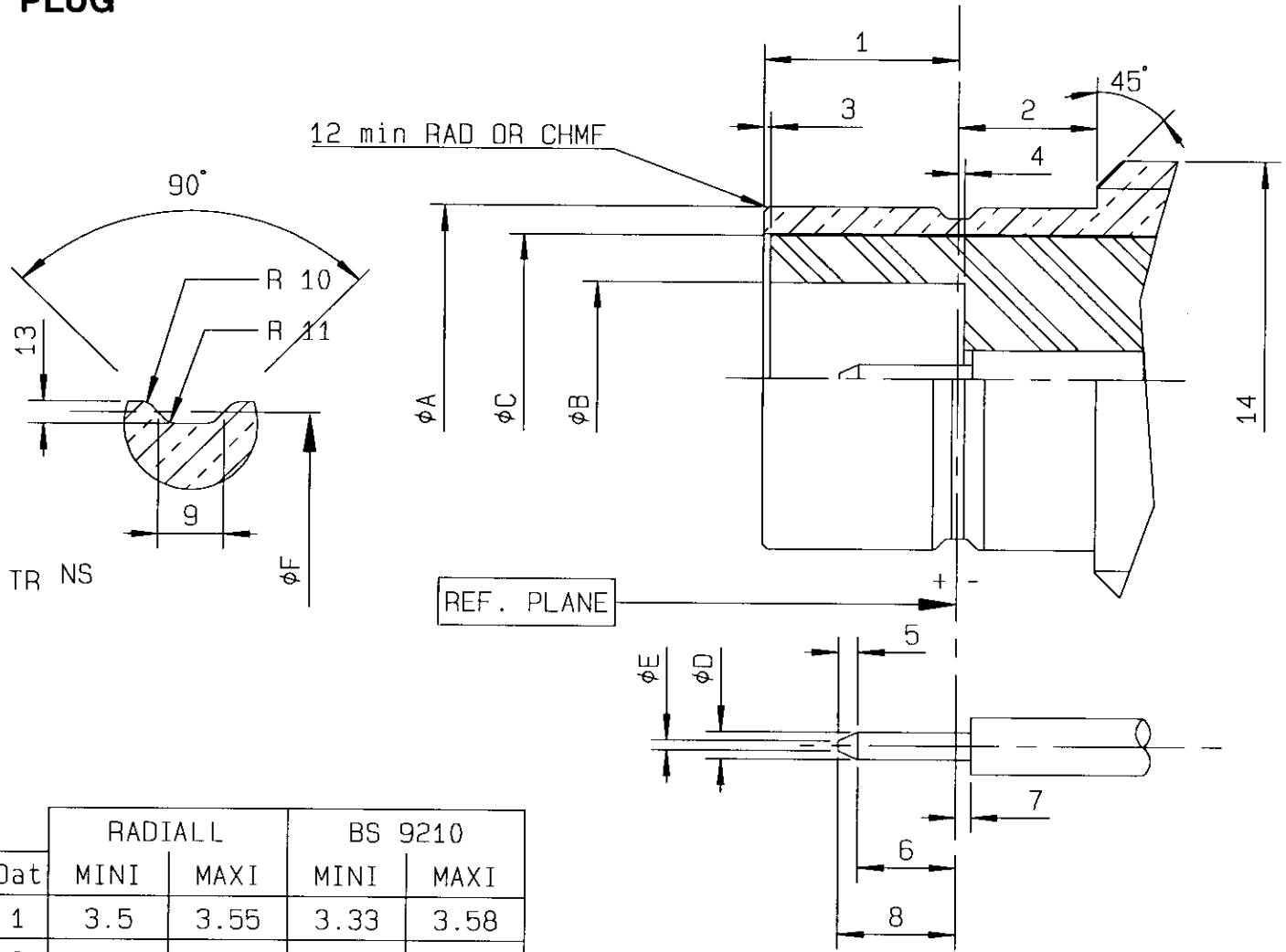

Dat	RADIALL		BS 9210	
	MINI	MAXI	MINI	MAXI
1	3.5	3.55	3.33	3.58
2	2.40	2.55	2.01	-
3	0.00	0.10	0.00	-
4	0.05	0.175	-	0.18
5	0.25	0.35	0.25	-
6	1.35	-	1.32	-
7	-	0.18	-	0.18
8	-	2.05	-	2.97
9	0.58 NOM		0.58 NOM	
10	0.05	0.15	0.05	0.15
11	-	0.13	-	0.13
12	0.10	0.20	0.10	
13	0.15	0.25	0.15	0.25
14	5/16" 32 UNEF-2A		-	7.94

Dat	RADIALL		BS 9210	
	MINI	MAXI	MINI	MAXI
ϕA	6.20	6.23	6.20	6.25
ϕB	3.40	3.475	3.35	-
ϕC	5.25 NOM		5.60 NOM	
ϕD	0.48	0.52	0.48	0.53
ϕE	0.125	0.225	-	0.25
ϕF	5.97	6.02	5.97	6.07

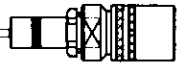

SOCKET

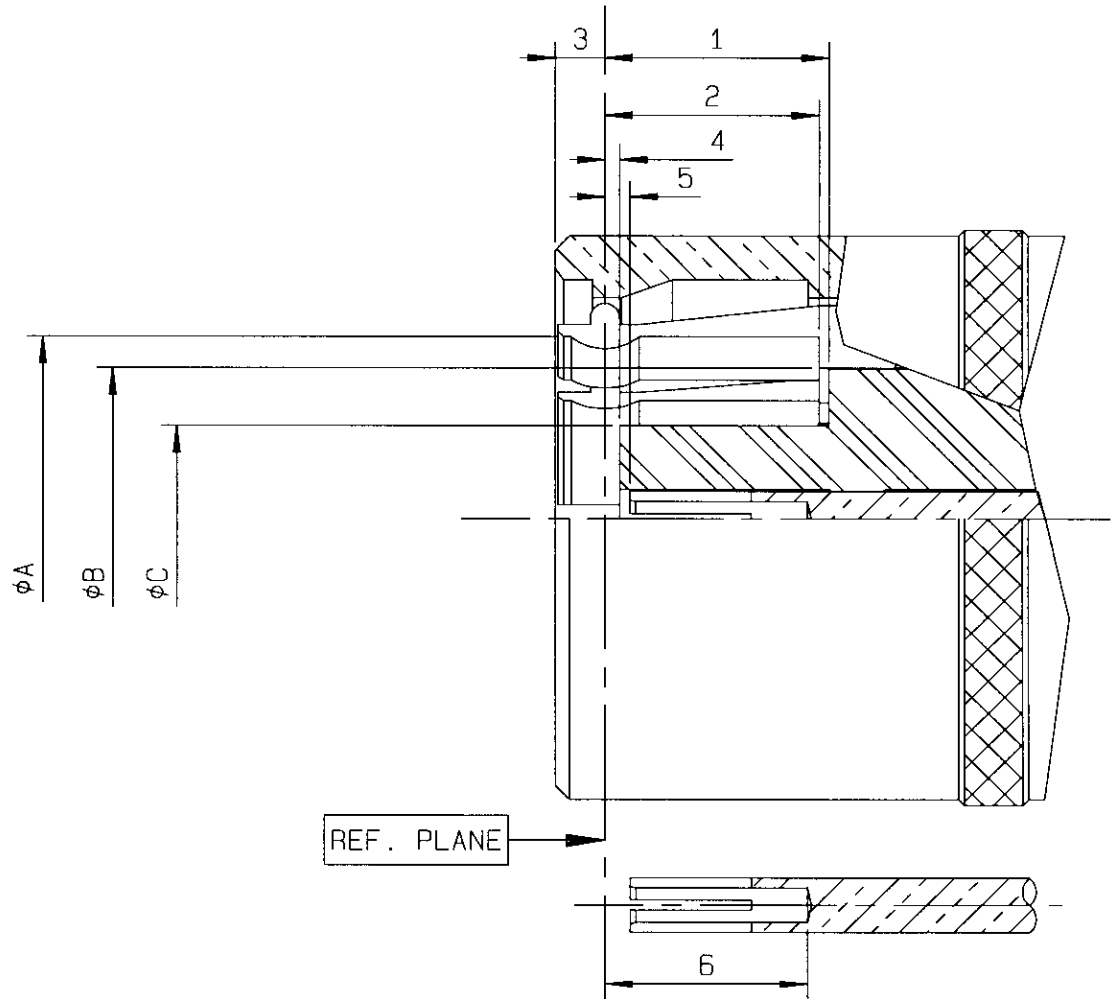

Dat	RADIALL		BS 9210	
	MINI	MAXI	MINI	MAXI
1	3.63	3.83	3.58	-
2	3.61	3.77	3.58	-
3	-	1.8	-	2.36
4	0.23	0.38	0.18	-
5	0.23	0.48	0.18	0.94
6	3.2	3.53	2.97	-

Dat	RADIALL		BS 9210	
	MINI	MAXI	MINI	MAXI
ϕA	6.31	6.36	6.25	-
ϕB	5.25 NOM		5.60 NOM	
ϕC	3.22	3.30	-	3.33

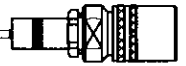

STD Straight plug, full crimp type, snap DDF mount (multi piece body)

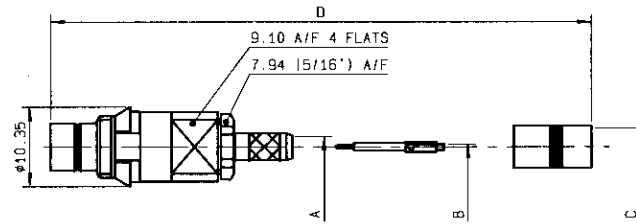
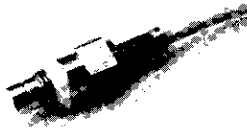

Industry (BT) P/N	Cable Group	Radiall P/N Single Pack	Single Pack Quantity	Radiall P/N Multi-Pack	Multi-Pack Quantity	Dim. A	Dim. B	Dim. C	Dim. D	Panel	Mounting
P43/1GTI	2001	R214 312 740	1	R214 312 744	100	2.65	0.74	4.80	35.00	P01	M02
P43/2GTI	2002	R214 312 760	1	R214 312 764	100	2.65	0.74	5.53	35.00	P01	M02
P43/3GTI	2003	R214 312 780	1	R214 312 784	100	3.95	0.74	7.20	35.00	P01	M02
P43/4GTI	RG179	R214 312 700	1	R214 312 704	100	1.73	0.38	3.25	35.00	P01	M02
P43/5GTI	3002/TZC75024	R214 312 720	1	R214 312 724	100	2.15	0.35	4.52	35.00	P01	M02

STD Straight plug, full crimp type, bulkhead DDF mount (multi piece body)

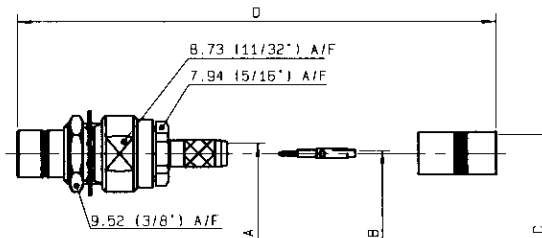
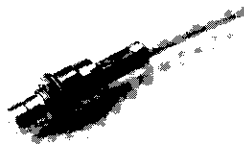

Industry (BT) P/N	Cable Group	Radiall P/N Single Pack	Single Pack Quantity	Radiall P/N Multi-Pack	Multi-Pack Quantity	Dim. A	Dim. B	Dim. C	Dim. D	Panel	Mounting
P43/1F	2001	R214 314 740	1	Not applicable		2.65	0.74	4.80	30.00	P02	M02
P43/2F	2002	R214 314 760	1	Not applicable		2.65	0.74	5.53	30.00	P02	M02
P43/3F	2003	R214 314 780	1	Not applicable		3.95	0.74	7.20	30.00	P02	M02
P43/4F	RG179	R214 314 700	1	Not applicable		1.73	0.38	3.25	30.00	P02	M02
P43/5F	3002/TZC75024	R214 314 720	1	Not applicable		2.15	0.35	4.52	30.00	P02	M02



STD Straight socket, full crimp type (single piece body)

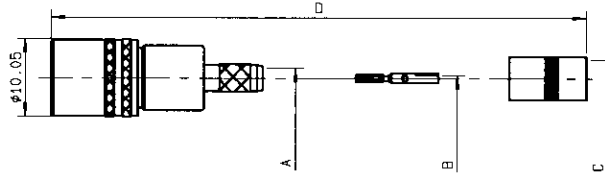

Industry (BT) P/N	Cable Group	Radial P/N Single Pack	Single Pack Quantity	Radial P/N Multi-Pack	Multi-Pack Quantity	Dim. A	Dim. B	Dim. C	Dim. D	Mounting
S43/1FS	2001	Not applicable		R214 083 942	20	2.65	0.74	4.80	32.00	M01
S43/2FS	2002	Not applicable		R214 083 962	20	2.65	0.74	5.53	32.00	M01
S43/3FS	2003	Not applicable		R214 083 982	20	3.95	0.74	7.20	32.00	M01
S43/4FS	RG179	Not applicable		R214 083 902	20	1.73	0.38	3.25	32.00	M01
S43/5FS	3002/TZC75024	Not applicable		R214 083 922	20	2.15	0.35	4.52	32.00	M01

STD Straight socket, full crimp type (multi piece body)

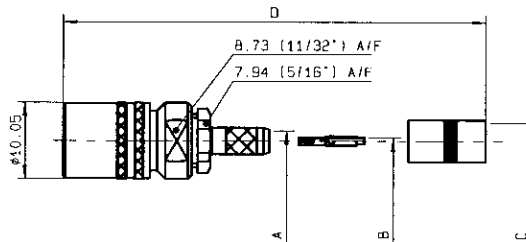

Industry (BT) P/N	Cable Group	Radial P/N Single Pack	Single Pack Quantity	Radial P/N Multi-Pack	Multi-Pack Quantity	Dim. A	Dim. B	Dim. C	Dim. D	Mounting
S43/1F	2001	R214 082 940	1	R214 082 944	100	2.65	0.74	4.80	32.00	M02
S43/2F	2002	R214 082 960	1	R214 082 964	100	2.65	0.74	5.53	32.00	M02
S43/3F	2003	R214 082 980	1	R214 082 984	100	3.95	0.74	7.20	32.00	M02
S43/4F	RG179	R214 082 900	1	R214 082 904	100	1.73	0.38	3.25	32.00	M02
S43/5F	3002/TZC75024	R214 082 920	1	R214 082 924	100	2.15	0.35	4.52	32.00	M02

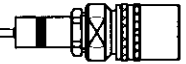

STD Right angle socket, solder/crimp type

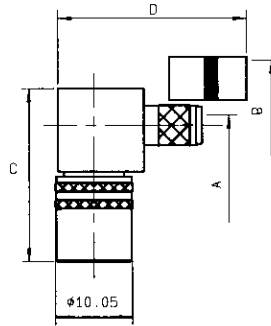

Industry (BT) P/N	Cable Group	Radiall P/N Single Pack	Single Pack Quantity	Radiall P/N Multi-Pack	Multi-Pack Quantity	Dim. A	Dim. B	Dim. C	Dim. D	Mounting
S43/1C	2001	R214 182 940	1	R214 182 942	20	2.65	4.80	23.00	25.00	M03
S43/2C	2002	R214 182 960	1	R214 182 962	20	2.65	5.53	23.00	25.00	M03
S43/3C	2003	R214 182 980	1	R214 182 982	20	3.95	5.53	23.00	25.00	M03
S43/4C	RG179	R214 182 900	1	R214 182 902	20	1.73	3.25	23.00	25.00	M03
S43/5C	3002/TZC75024	R214 182 920	1	R214 182 922	20	2.15	4.52	23.00	25.00	M03

STD U-link

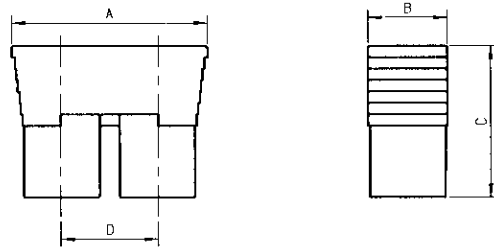

Industry (BT) P/N	Radiall P/N Single Pack	Single Pack Quantity	Radiall P/N Multi-Pack	Multi-Pack Quantity	Dim. A	Dim. B	Dim. C	Dim. D
U - LINK 13A	R214 790 700	1	R214 790 703	50	25.40	10.20	19.80	12.70

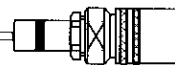

STD U-link with test port

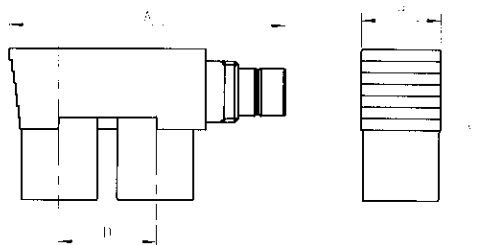

Industry (BT) P/N	Radial P/N Single Pack	Single Pack Quantity	Radial P/N Multi-Pack	Multi-Pack Quantity	Dim. A	Dim. B	Dim. C	Dim. D
U - LINK 13B	R214 791 700	1	R214 791 703	50	35.60	10.20	19.80	12.70

STD Straight PCB mount plug

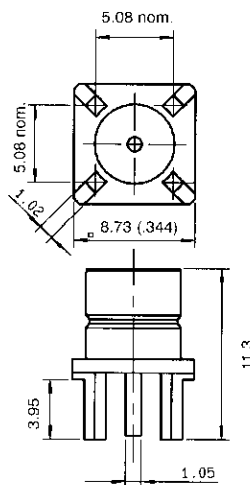

Industry (BT) P/N	Radial P/N Single Pack	Single Pack Quantity	Radial P/N Multi-Pack	Multi-Pack Quantity	PCB
P43/1D	R214 426 700	1	R214 426 704	100	P05

Type 43, straight, PCB mount receptacles/plugs are also available with press-fit terminations (solderless pins) suitable for 1.00mm diameter (nominal) holes. For full details concerning press-fit Type 43 and other press-fit coaxial connectors, please see the **RADIAL** application guide for PRESS-FIT technology P/N : D1 015 DE.



STD Right-angle PCB mount plug

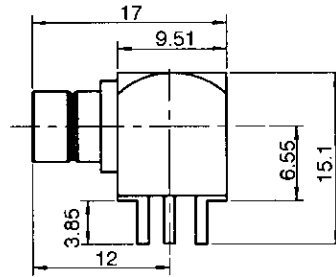
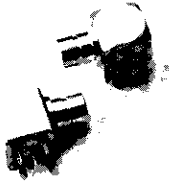

Industry (BT) P/N	Radial P/N Single Pack	Single Pack Quantity	Radial P/N Multi-Pack	Multi-Pack Quantity	PCB
P43/1E	R214 665 700	1	R214 665 704	100	P05

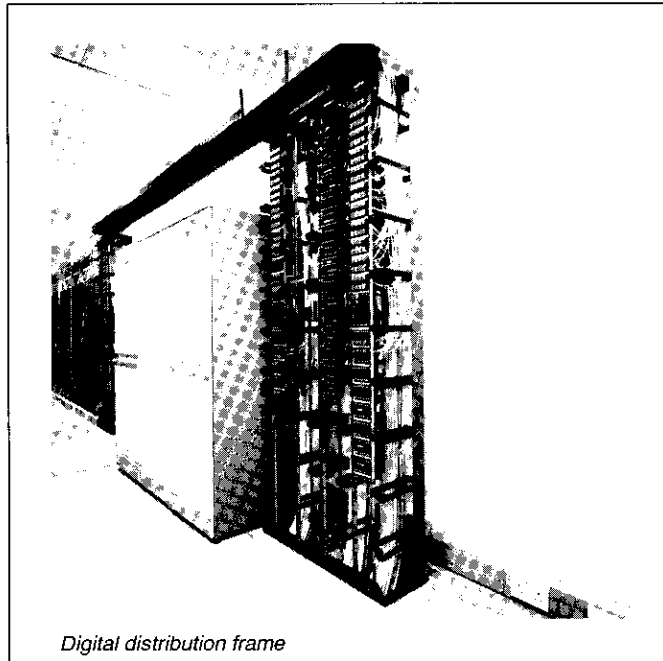



HDC Straight plug, full crimp type, snap DDF mount (single piece body)

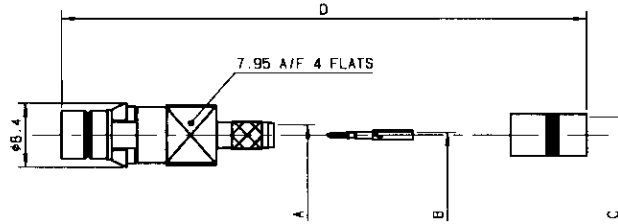

Industry (BT) P/N	Cable Group	Radiall P/N Single Pack	Single Pack Quantity	Radiall P/N Multi-Pack	Multi-Pack Quantity	Dim. A	Dim. B	Dim. C	Dim. D	Panel	Mounting
HDCP43/1GTIS	2001	Not applicable		R214 318 742	20	2.65	0.72	4.80	35.00	P03	M01
HDCP43/2GTIS	2002	Not applicable		R214 318 762	20	2.65	0.72	5.53	35.00	P03	M01
HDCP43/3GTIS	2003	Not applicable		R214 318 782	20	3.95	0.74	7.20	35.00	P03	M01
HDCP43/4GTIS	RG179	Not applicable		R214 318 702	20	1.73	0.38	3.25	35.00	P03	M01
HDCP43/5GTIS	3002/TZC75024	Not applicable		R214 318 722	20	2.15	0.35	4.52	35.00	P03	M01

HDC Straight plug, full crimp type, snap DDF mount (multi piece body)

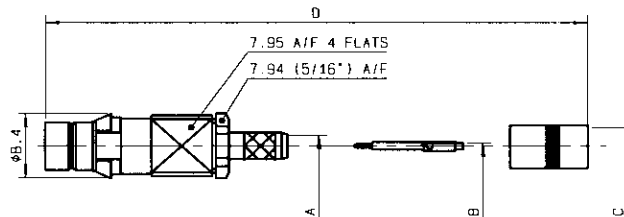
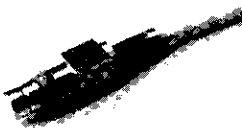

Industry (BT) P/N	Cable Group	Radiall P/N Single Pack	Single Pack Quantity	Radiall P/N Multi-Pack	Multi-Pack Quantity	Dim. A	Dim. B	Dim. C	Dim. D	Panel	Mounting
HDCP43/1GTI	2001	R214 317 740	1	R214 317 744	100	2.65	0.72	4.80	35.00	P03	M02
HDCP43/2GTI	2002	R214 317 760	1	R214 317 764	100	2.65	0.72	5.53	35.00	P03	M02
HDCP43/3GTI	2003	R214 317 780	1	R214 317 784	100	3.95	0.72	7.20	35.00	P03	M02
HDCP43/4GTI	RG179	R214 317 700	1	R214 317 704	100	1.73	0.38	3.25	35.00	P03	M02
HDCP43/5GTI	3002/TZC75024	R214 317 720	1	R214 317 724	100	2.15	0.35	4.52	35.00	P03	M02

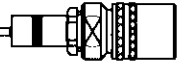

HDC Straight socket, full crimp type (single piece body)

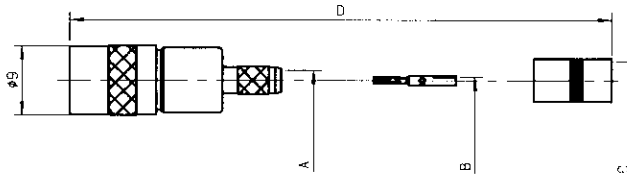

Industry (BT) P/N	Cable Group	Radial P/N Single Pack	Single Pack Quantity	Radial P/N Multi-Pack	Multi-Pack Quantity	Dim. A	Dim. B	Dim. C	Dim. D	Mounting
HDCS43/1FS	2001	Not applicable		R214 088 942	20	2.65	0.74	4.80	32.00	M01
HDCS43/2FS	2002	Not applicable		R214 088 962	20	2.65	0.74	5.53	32.00	M01
HDCS43/3FS	2003	Not applicable		R214 088 982	20	3.95	0.74	7.20	32.00	M01
HDCS43/4FS	RG179	Not applicable		R214 088 902	20	1.73	0.38	3.25	32.00	M01
HDCS43/5FS	3002/TZC75024	Not applicable		R214 088 922	20	2.15	0.35	4.52	32.00	M01

HDC Straight socket, full crimp type (multi piece body)

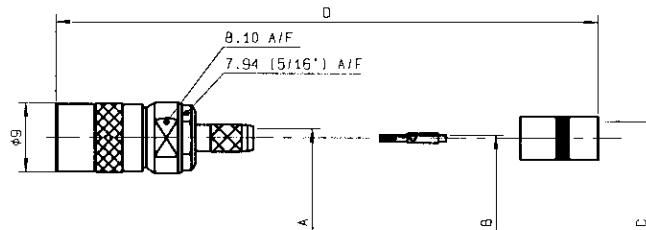
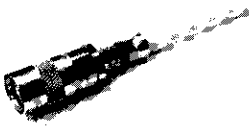

Industry (BT) P/N	Cable Group	Radial P/N Single Pack	Single Pack Quantity	Radial P/N Multi-Pack	Multi-Pack Quantity	Dim. A	Dim. B	Dim. C	Dim. D	Mounting
HDCS43/1F	2001	R214 087 940	1	R214 087 944	20	2.65	0.74	4.80	32.00	M02
HDCS43/2F	2002	R214 087 960	1	R214 087 964	20	2.65	0.74	5.53	32.00	M02
HDCS43/3F	2003	R214 087 980	1	R214 087 984	20	3.95	0.74	7.20	32.00	M02
HDCS43/4F	RG179	R214 087 900	1	R214 087 904	20	1.73	0.38	3.25	32.00	M02
HDCS43/5F	3002/TZC75024	R214 087 920	1	R214 087 924	20	2.15	0.35	4.52	32.00	M02

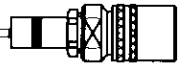

HDC U-link

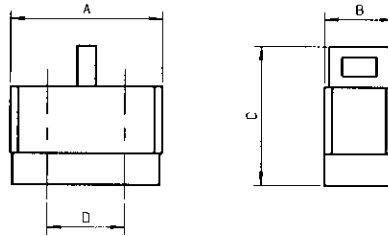

Industry (BT) P/N	Radial P/N Single Pack	Single Pack Quantity	Radial P/N Multi-Pack	Multi-Pack Quantity	Dim. A	Dim. B	Dim. C	Dim. D
U - LINK 10A	R214 797 700	1	R214 797 703	50	19.60	9.50	18.00	10.00

HDC U-link, with test port

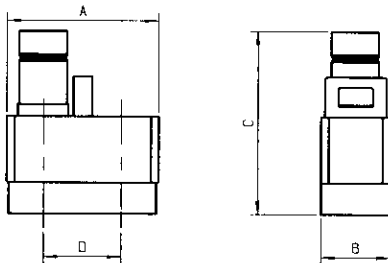

Industry (BT) P/N	Radial P/N Single Pack	Single Pack Quantity	Radial P/N Multi-Pack	Multi-Pack Quantity	Dim. A	Dim. B	Dim. C	Dim. D
U - LINK 10B	R214 798 700	1	R214 798 703	50	19.60	9.50	24.00	10.00



UHDC Straight plug, full crimp type, snap DDF mount (single piece body)

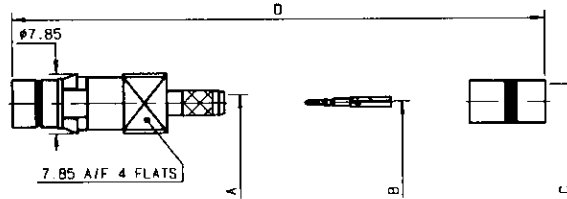
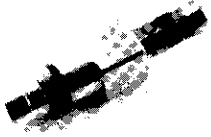

Industry (BT) P/N	Cable Group	Radial P/N Single Pack	Single Pack Quantity	Radial P/N Multi-Pack	Multi-Pack Quantity	Dim. A	Dim. B	Dim. C	Dim. D	Panel	Mounting
UHDCP43/5GTIS	3002/TZC75024	Not applicable		R214 320 722	20	2.15	0.35	4.52	35.00	P04	M01

UHDC Straight socket, full crimp type (single piece body)

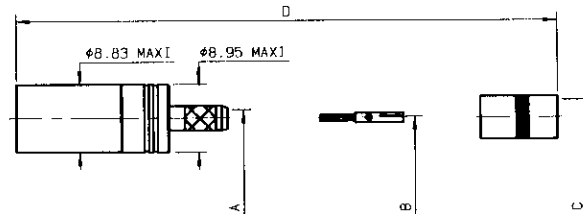
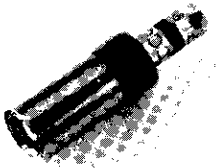

Industry (BT) P/N	Cable Group	Radial P/N Single Pack	Single Pack Quantity	Radial P/N Multi-Pack	Multi-Pack Quantity	Dim. A	Dim. B	Dim. C	Dim. D	Mounting
UHDCS43/5FS	3002/TZC75024	Not applicable		R214 089 922	20	2.15	0.35	4.52	30.00	M01



UHDC U-link

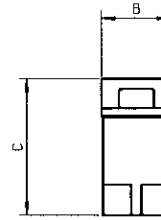
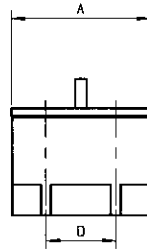
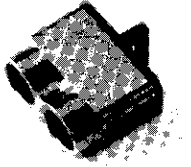

Industry (BT) P/N	Radial P/N Single Pack	Single Pack Quantity	Radial P/N Multi-Pack	Multi-Pack Quantity	Dim. A	Dim. B	Dim. C	Dim. D
U - LINK 9A	Not applicable		R214 797 721	10	17.90	8.85	18.00	9.00

UHDC U-link with test port

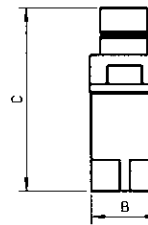
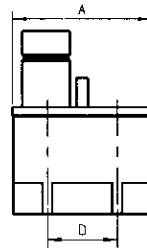
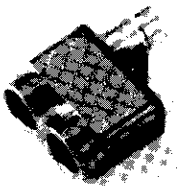

Industry (BT) P/N	Radial P/N Single Pack	Single Pack Quantity	Radial P/N Multi-Pack	Multi-Pack Quantity	Dim. A	Dim. B	Dim. C	Dim. D
U - LINK 9B	Not applicable		R214 798 721	10	17.90	8.85	24.00	9.00

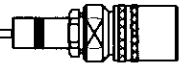

BNC Straight plug, full crimp type

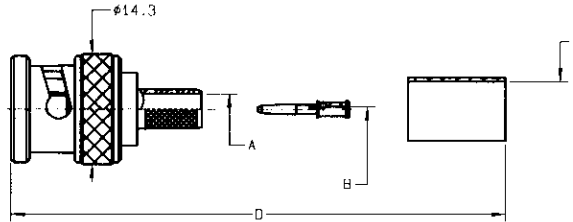

Industry (BT) P/N	Cable Group	Radiall P/N Single Pack	Single Pack Quantity	Radiall P/N Multi-Pack	Multi-Pack Quantity	Dim. A	Dim. B	Dim. C	Dim. D	Mounting
BNC, STRAIGHT	2001	R142 081 320	1	R142 081 330	100	2.75	0.68	4.75	29.00	M04
BNC, STRAIGHT	2002	R142 083 320	1	R142 083 330	100	2.75	0.68	5.50	29.00	M04
BNC, STRAIGHT	2003	R142 086 320	1	R142 086 340	100	3.95	0.68	7.15	29.00	M04
BNC, STRAIGHT	RG179	R142 076 000	1	R142 076 170	100	1.80	0.40	3.00	31.00	M04
BNC, STRAIGHT	3002/TZC75024	R142 081 120	1	R142 081 130	100	2.35	0.35	4.42	29.00	M04

BNC Right-angle plug, solder crimp type

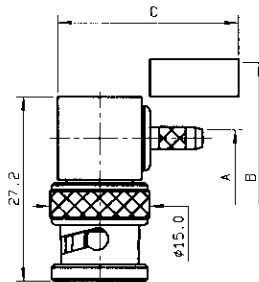

Industry (BT) P/N	Cable Group	Radiall P/N Single Pack	Single Pack Quantity	Radiall P/N Multi-Pack	Multi-Pack Quantity	Dim. A	Dim. B	Dim. C	Mounting
BNC, R/ANGLE	2002	R142 181 200W	1	R142 181 200	100	2.70	5.46	27.00	M03
BNC, R/ANGLE	2003	R142 185 200W	1	R142 185 200	100	3.90	7.15	27.00	M03
BNC, R/ANGLE	3002/TZC75024	R142 177 200W	1	R142 177 200	100	2.30	4.52	26.00	M03

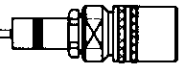

BNC, Straight jack, full crimp type, bulkhead panel mount

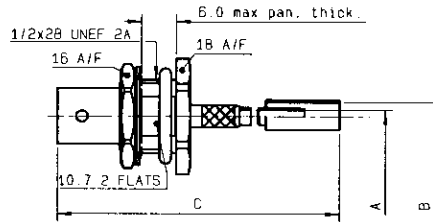

Industry (BT) P/N	Cable Group	Radial P/N Single Pack	Single Pack Quantity	Radial P/N Multi-Pack	Multi-Pack Quantity	Dim. A	Dim. B	Dim. C	Mounting
BNC, STRAIGHT	2002	PLEASE CONSULT FACTORY FOR AVAILABILITY							
BNC, STRAIGHT	2003	PLEASE CONSULT FACTORY FOR AVAILABILITY							
BNC, STRAIGHT	RG179	R142 331 011	1	R142 331 020	100	1.75	3.25	38.00	M06
BNC, STRAIGHT	3002/TZC75024	R142 325 100W	1	R142 325 106	100	2.10	4.42	36.00	M06

Type 43/BNC Adapter

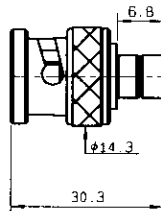

Industry (BT) P/N	Radial P/N Single Pack	Single Pack Quantity
P43 TO BNC PLUG	R192 486 000	1

Other Type 43 adapter products are also available, these include:

- in series Type 43 plug to Type 43 plug bulkhead adapter (part No.: **R214 721 703**),
- between series Type 43 socket to BNC jack right angle adapter (part No.: **R192 489 500**).

Detailed technical data sheets available, please consult your RADIALL representative for further details.

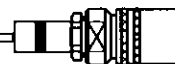

R/A plug, solder crimp type

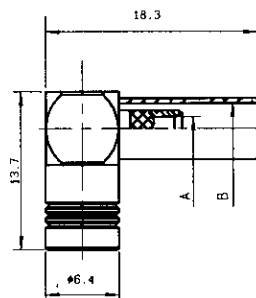

Industry (BT) P/N	Cable Group	Radiall P/N Single Pack	Single Pack Quantity	Dim. A	Dim. B	Mounting
SMB, R/ANGLE,	RG179	R114 186 100	1	1.70	3.25	M05
SMB, R/ANGLE,	3002/TZC75024	R114 191 300	1	2.10	4.40	M05

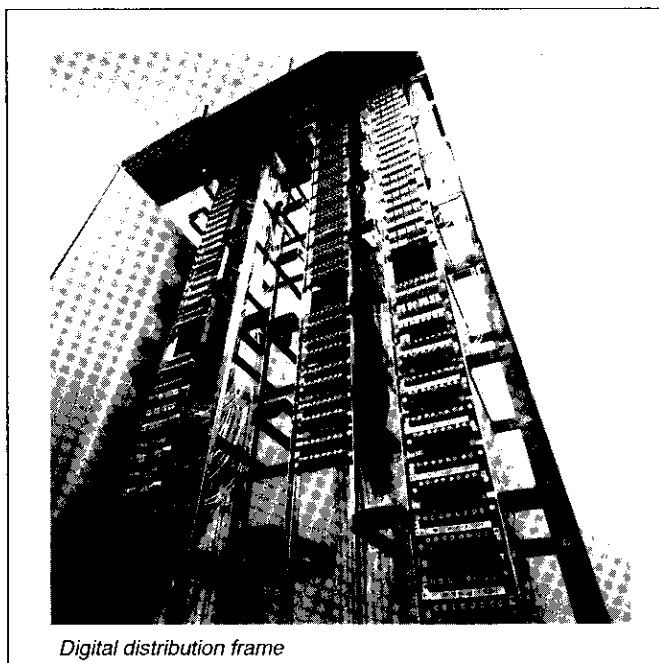

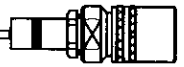

Type 43 Series

Product Description	Transradio P/N	Radiall P/N
Complete Tool Kit *	Q92464	R282 127 000
Centre Contact Crimp Tool - 8 Indentation	Q92434	R282 281 010
Outer Contact Crimp Tool Frame	Q92316	R282 287 000
Outer Contact Crimp Die 2002	Q92437	R282 265 003
Outer Contact Crimp Die 2003	Q92436	R282 265 004
Outer Contact Crimp Die RG179	Q92441	R282 265 001
Outer Contact Crimp Die 3002/TZC75024	Q92435	R282 265 002
Cable Stripping Tool 2002, 2003 & 3002/TZC75024	Q92465	R282 079 000
Side Cutters	Q92353	R282 201 010
3-Way HDC Plug/Link Mounting and Release Tool	Q92445	R282 868 201
Torque Spanner 1Nm	Not applicable	R282 320 000

* Complete Tool Kit - features all tools listed below contained in a durable black plastic tool box.

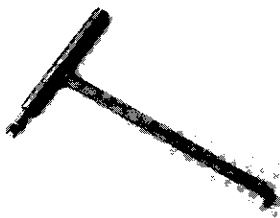

R282 868 201

Type 43 Series Outer Contact - Crimp Die Sizes

Cable	Transradio Part No.	Radiall Part No.	Hex Dimensions (A/F - Nominal)	
			Outer (mm)	Inner (mm)
2002	Q92437	R282 265 003	5.18	1.46
2003	Q92436	R282 265 004	6.81	1.46
RG179	Q92441	R282 265 001	3.25	Not applicable
3002/TZC75024	Q92435	R282 265 002	4.52	1.46

Cable	Cable group	Contact	Sleeve	
		Crimp tool	Crimp tool	Dies
RG 179	2.6/75SS	R282 281 010	R282 287 000	R282 265 001 (Hex. 3.25)
BT 3002	3.6/75DS	R282 281 010	R282 287 000	R282 265 002 (Hex. 4.52)
BT2001	4.4/75SS	R282 281 010	R282 287 000	R282 265 002 (Hex. 4.52)
BT 2002	5.1/75DS	R282 281 010	R282 287 000	R282 265 003 (Hex. 5.18)
BT 2003	6.7/75DS	R282 281 010	R282 287 000	R282 265 004 (Hex. 6.81)

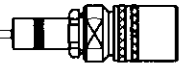

STANDARD

P01

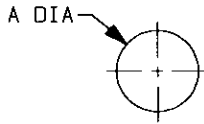

	MM		INCH	
	maxi	mini	maxi	mini
A	9.35	9.15	0.368	0.36

PLUG 43/G
PLUG 43/GTI
PLUG 43/GTIS

STANDARD

P02

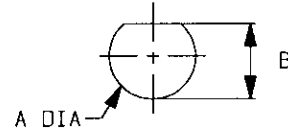

	MM		INCH	
	maxi	mini	maxi	mini
A	8.04	7.94	0.317	0.31
B	7.5	7.4	0.295	0.291

PLUG 43/F

HDC

P03

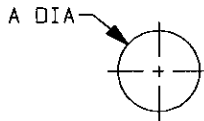

	MM		INCH	
	maxi	mini	maxi	mini
A	7.55	7.50	0.297	0.295

PLUG HDC43/GTI
PLUG HDC43/GTIS

UHDC

P04

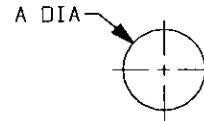

	MM		INCH	
	maxi	mini	maxi	mini
A	7.35	7.05	0.289	0.278

PLUG UHDC43/GTIS

PCB

P05

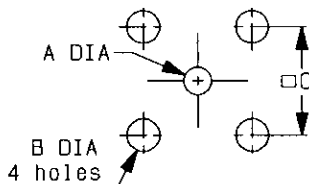

	MM		INCH	
	maxi	mini	maxi	mini
A	1.5	1.2	0.059	0.047
B	2	1.7	0.079	0.067
C	5.1	5.05	0.201	0.199

PLUG 43/1E
PLUG 43/1D

M 01

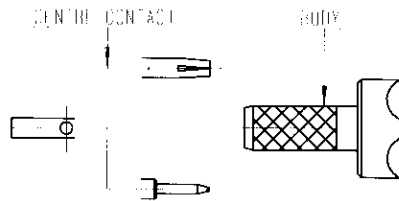
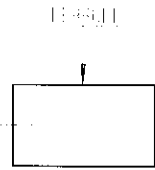
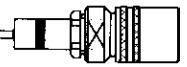

1

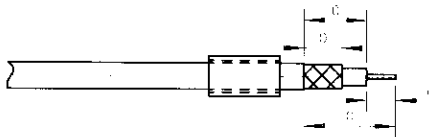

2

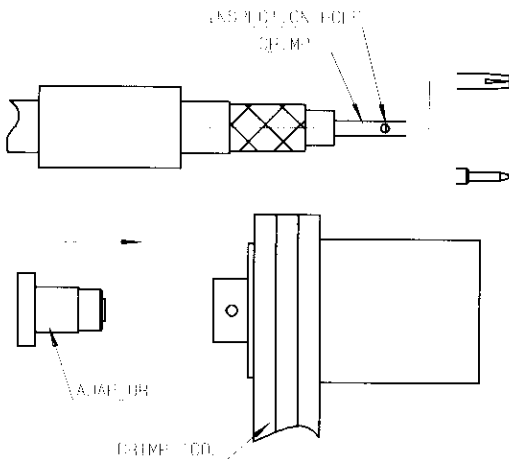

3

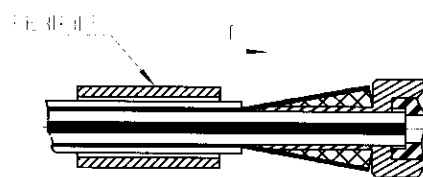

4

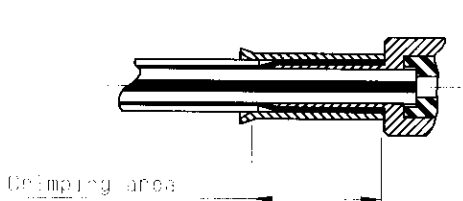

CONNECTORS	STRIPPING LENGTH (mm)				CONTACT	CRIMPING TOOL	
	a	b	c	e		FERRULE	
						Crimp tool : R 282 287 000	
		Dies	Hex. dimension (mm)				
R 214 083 942	4,5	8	21	16,5	R282 281 010	R282 265 002	4,52
R 214 083 962						R282 265 003	5,18
R 214 083 982						R282 265 004	6,81
R 214 083 902						R282 265 001	3,25
R 214 083 922						R282 265 002	4,52
R 214 088 942						R282 265 003	5,18
R 214 088 962						R282 265 004	6,81
R 214 088 982						R282 265 001	3,25
R 214 088 902						R282 265 002	4,52
R 214 088 922						R282 265 003	5,18
R 214 089 922						R282 265 004	6,81
R 214 313 742						R282 265 001	3,25
R 214 313 762						R282 265 002	4,52
R 214 313 782						R282 265 003	5,18
R 214 313 702						R282 265 004	6,81
R 214 313 722						R282 265 001	3,25
R 214 318 722						R282 265 002	4,52
R 214 318 762						R282 265 003	5,18
R 214 318 782						R282 265 004	6,81
R 214 318 702						R282 265 001	3,25
R 214 318 722	R282 265 002	4,52					
R 214 320 722	R282 265 003	5,18					

- 1.1 Slide ferrule onto cable.
- 1.2 Strip cable.

- 2.1 Place centre contact on conductor.
(ensure conductor is visible through inspection hole)
- 2.2 Place adaptor in crimp tool.
- 2.3 Insert cable into adaptor. Push home.
- 2.4 Crimp centre contact.

- 3.1 Guide dielectric into connector while fanning braid.
- 3.2 Push home until centre contact "clicks" into place".

- 4.1 Slide crimp sleeve forward until sleeve butts up against body.
- 4.2 Crimp ferrule.

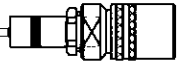

M 02

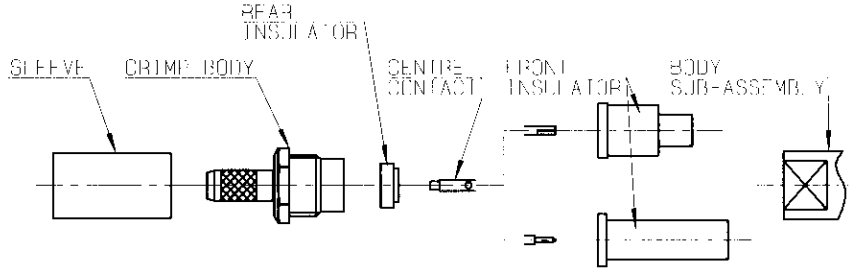

1

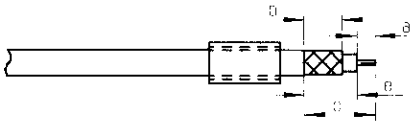

2

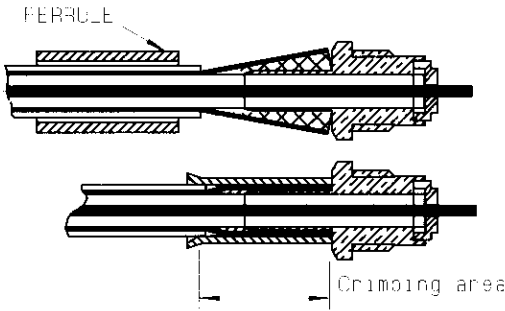

3

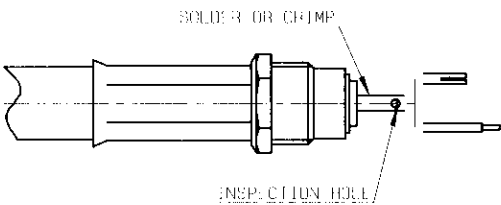

4

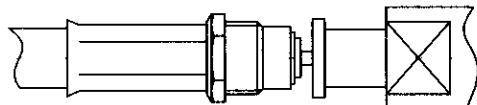

CONNECTORS	STRIPPING LENGTH (mm)				CONTACT	CRIMPING TOOL	
	a	b	c	e		FERRULE	
						Crimp tool : R 282 287 000	
					Dies	Hex. dimension (mm)	
R 214 082 944						R282 265 002	4,52
R 214 082 964						R282 265 003	5,18
R 214 082 984						R282 265 004	6,81
R 214 082 904						R282 265 001	3,25
R 214 082 924						R282 265 002	4,52
R 214 087 944						R282 265 003	5,18
R 214 087 964						R282 265 004	6,81
R 214 087 984						R282 265 001	3,25
R 214 087 904						R282 265 002	4,52
R 214 087 924						R282 265 003	5,18
R 214 311 744						R282 265 004	6,81
R 214 311 764						R282 265 001	3,25
R 214 311 784						R282 265 002	4,52
R 214 311 704						R282 265 003	5,18
R 214 311 724	4,5	8	21	16,5	R282 281 010	R282 265 002	4,52
R 214 312 744						R282 265 003	5,18
R 214 312 764						R282 265 004	6,81
R 214 312 784						R282 265 001	3,25
R 214 312 704						R282 265 002	4,52
R 214 312 724						R282 265 003	5,18
R 214 314 740						R282 265 004	6,81
R 214 314 760						R282 265 001	3,25
R 214 314 780						R282 265 002	4,52
R 214 314 700						R282 265 003	5,18
R 214 314 720						R282 265 004	6,81
R 214 317 744						R282 265 001	3,25
R 214 317 764						R282 265 002	4,52
R 214 317 784						R282 265 003	5,18
R 214 317 704						R282 265 004	6,81
R 214 317 724						R282 265 001	3,25
						R282 265 002	4,52

- 1.1 Slide ferrule onto cable.
- 1.2 Strip cable.
- 2.1 Guide cable dielectric into crimp body while fanning braid.
- 2.2 Ensure body abutts cable.
- 2.3 Slide ferrule forward until ferrule abutts crimp body.
- 2.4 Crimp ferrule.
- 3.1 Place centre contact on inner conductor ensure centre contact is seated on insulator. (inner conductor will be visible through inspection hole).
- 3.2 Crimp/solder centre contact.
- 4.1 Place front insulator over centre contact.
- 4.2 Ensure it sits firmly on spigot on rear insulator.
- 4.3 Place body sub-assembly over front insulator.
- 4.4 Screw on body sub-assembly on to crimp body and tighten.
- 4.5 Typical tightening torque 100 cm N.



STANDARD

P01

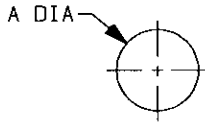

	MM		INCH	
	maxi	mini	maxi	mini
A	9.35	9.15	0.368	0.36

PLUG 43/G
PLUG 43/GTI
PLUG 43/GTIS

STANDARD

P02

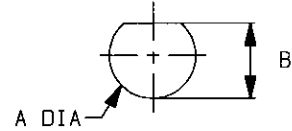

	MM		INCH	
	maxi	mini	maxi	mini
A	8.04	7.94	0.317	0.31
B	7.5	7.4	0.295	0.291

PLUG 43/F

HDC

P03

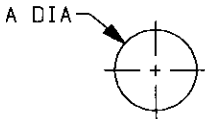

	MM		INCH	
	maxi	mini	maxi	mini
A	7.55	7.50	0.297	0.295

PLUG HDC43/GTI
PLUG HDC43/GTIS

UHDC

P04

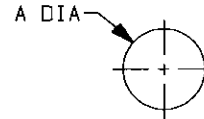

	MM		INCH	
	maxi	mini	maxi	mini
A	7.35	7.05	0.289	0.278

PLUG UHDC43/GTIS

PCB

P05

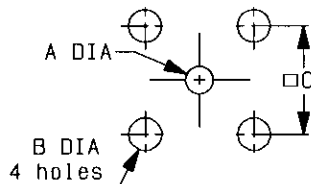

	MM		INCH	
	maxi	mini	maxi	mini
A	1.5	1.2	0.059	0.047
B	2	1.7	0.079	0.067
C	5.1	5.06	0.201	0.199

PLUG 43/1E
PLUG 43/1D

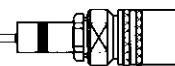

M 04

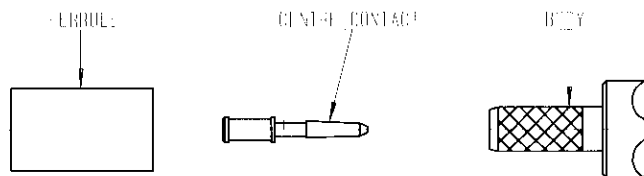

CONNECTORS	STRIPPING LENGTH (mm)				CONTACT	CRIMPING TOOL	
	a	b	c	e		FERRULE	Hex. dimension (mm)
R 142 081 330						Crimp tool : R 282 287 000	
R 142 083 330						Dies	
R 142 086 340	4	8,5	15	11	R282 281 010	R285 265 002	4,52
R 142 076 170						R282 265 003	5,18
R 142 081 130						R282 265 004	6,81
						R282 265 001	3,25
						R282 265 002	4,52

1

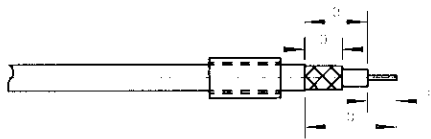

- 1.1 Slide ferrule onto cable.
- 1.2 Strip cable.

2

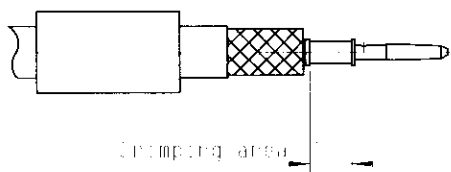

- 2.1 Slide on centre contact until it bottoms against cable dielectric.
- 2.2 Crimp centre contact.

3

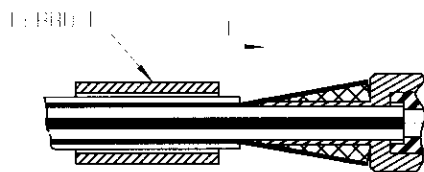

- 3.1 Fan the braid.
- 3.2 Slide cable into the body until bottoms against insulator.
- 3.3 Slide ferrule over the braid. (In direction F)

4

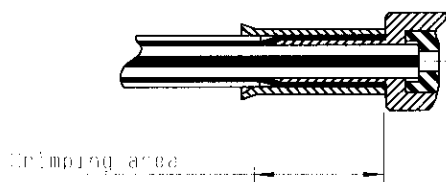

- 4.1 Crimp the ferrule with crimping tool.

M 05

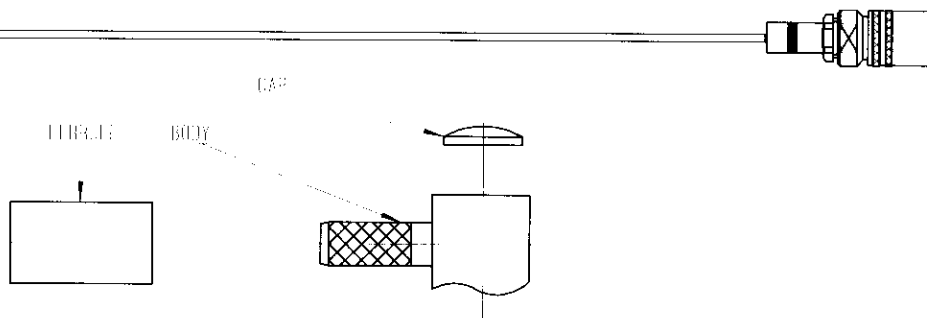

CONNECTORS	STRIPPING LENGTH (mm)				CRIMPING TOOL	
	a	b	c	e	FERRULE	
R 114 186 100	1,5	5,4	9,6	8,1	Crimp tool : R 282 287 000	
R 114 191 300					Dies	Hex. dimension (mm)
					R282 265 001	3,25
					R282 265 002	4,52

1

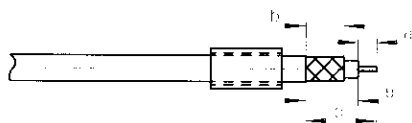

- 1.1 Slide ferrule onto cable.
- 1.2 Strip cable.

2

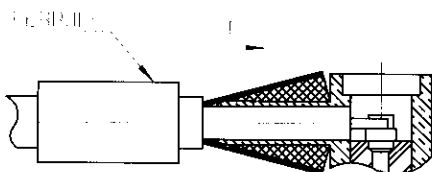

- 2.1 Fan the braid.
- 2.2 Push connector body under the braid.
- 2.3 Slide the ferrule on the braid.
(In direction F)

3

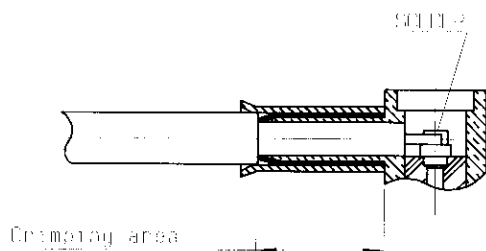

- 3.1 Crimp the ferrule with crimping tool.
- 3.2 Solder inner conductor.

4

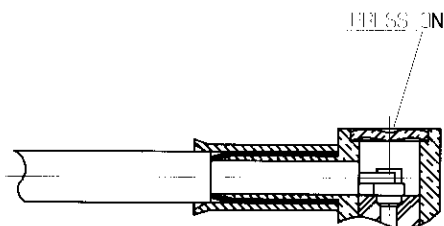

- 4.1 Place the cap.
- 4.2 Press cap flush or slightly below surface of body assembly.

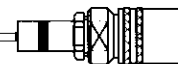

M 06

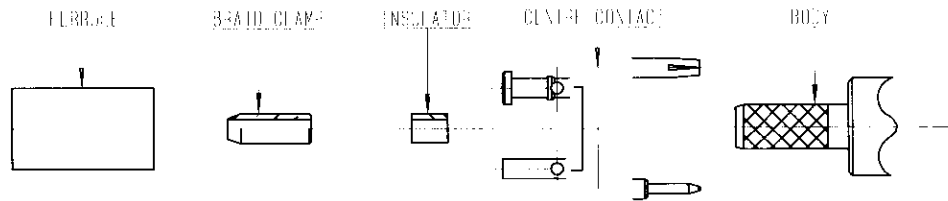

CONNECTORS	STRIPPING LENGTH (mm)				CONTACT	CRIMPING TOOL	
	a	b	c	e		FERRULE	
R 142 331 011						Crimp tool : R 282 287 000	
R 142 325 106	4	10	18,5	14,5	R 282 281 010	Dies	Hex. dimension (mm)
						R282 265 001	3,25
						R282 265 002	4,52



- 1.1 Slide ferrule onto cable.
- 1.2 Strip cable.

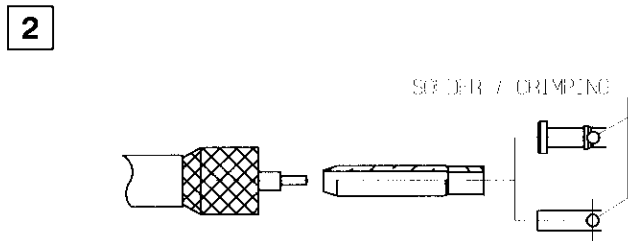

- 2.1 Fan the braid.
- 2.2 Slide the braid clamp and insulator between the dielectric and the braid.
- 2.3 Slide on centre contact until it bottoms against cable dielectric.
- 2.4 Solder or crimp centre contact.
- 2.5 Crimping tool R282 281 010.
+ dies R282 265 002 (Hex. 1.72)

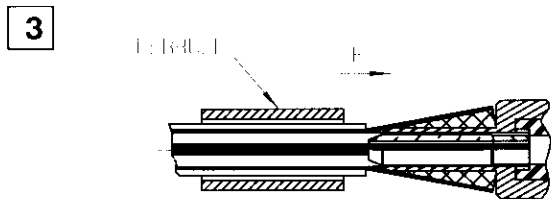

- 3.1 Slide cable into the body until bottoms against insulator.
- 3.2 Slide ferrule over the braid.
(In direction F)

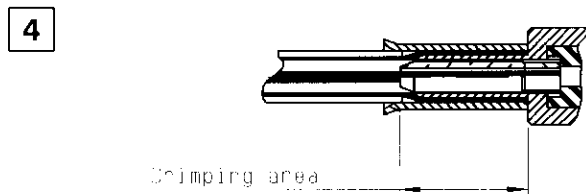

- 4.1 Crimp the ferrule with crimping tool.

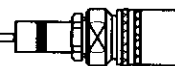
**Ambient temperature**

Temperature of the surrounding medium of an object

Analogue signals

Signals that vary in amplitude and frequency and are continuous in time. Voice signals originate as analogue signals.

Asynchronous transmission/Asynchronous transfer mode (ATM)

A class of data transmission service whereby all requests for service contend for a pool of dynamically allocated bandwidth and response time.

Attenuation

Reduction or loss of signal strength, measured in decibels; opposite of gain. The difference between transmitted and received power.

Balun

Unit for matching balanced lines (e.g. twisted pair cables) to unbalanced lines (e.g. coaxial cables) and vice versa.

Bandwidth

A measure of the amount of traffic the medium can handle at any one time. In digital communications, bandwidth describes the amount of data that can be transmitted over the line in bits-per-second.

Baseband

Transmission of digital signals without modulation. In a baseband network, the entire spectrum of the cable is used by the signal; does not allow frequency division multiplexing. IEEE 802.3 Ethernet uses baseband transmission.

Bit

A single character of a language being either of the binary digits 0 or 1.

Bit Rate

The number of bits of data transmitted over a communications line each second.

Block wiring

The inter-floor cabling and associated termination equipment that is installed between the distribution frames on different floors.

Broadcast

The process of sending a signal or message from one station on a network to other stations on the network.

Bus

A network term in which each terminal is connected in a line to a single cable. All devices have equal access to the network and can see all messages on the network, and each device selects the messages that are intended for it.

Community Antenna Television (CATV)

A Cable TV system.

International Telegraph and Telephone Consultative Committee (CCITT)**Central processing unit (CPU)**

The microprocessor that performs the central operations commands and computations in a computer.

Characteristic impedance

The value of resistance which, when connected to the end of a coaxial cable or transmission line (a pair), makes the line appear infinitely long. It ensures that there are no reflected waves along the line.

Crossconnect

Patch or connecting cable and passive hardware that is used to administer the connection of cables at a central or remote location.

Cross talk

Interference caused by signals from one circuit being picked up in an adjacent circuit. Cross talk can also occur between cables within a network or system.

Decibel (dB)

An expression of differences between input and output in the circuit. It can be used to express power gain in amplifiers or power loss in attenuators or cable assemblies.

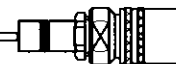
**Dielectric**

The insulating material between the two conductors in a coaxial cable or connector

Digital

A signal which only has two values, normally 0 and 1. The alternative method of transmission to analogue whose signal continually varies during transmission.

Distribution frame/digital distribution frame

A fixed unit, block or frame housing connectors or cable termination strips. Used to allow the cross connection of various types of building or telecom cabling to different types of telecommunications equipment.

Frequency division multiplex (FDM)

Separate carrier frequencies enable several signals to be transmitted at the same time. This is the only form of multiplexing that can be used with analogue signals.

Full duplex

A circuit or system that allows communication in both directions. Full Duplex, allows communications in both directions simultaneously (e.g. a normal telephone circuit).

Gain

The opposite to attenuation. The amount of signal amplification produced by a unit. Usually expressed in decibels (dBs).

Gateway

This term is used to describe an entrance into or exit out of a communications network. In telecommunications a gateway connects two otherwise incompatible networks. Gateways perform protocol conversion operations across a wide spectrum of communications functions or layers.

Half Duplex

This system allows communication in only one direction at a time (e.g. a push to talk intercom).

Integrated services digital network (ISDN)

A CCITT model for the integration of voice, images and data in a universal interface for telecommunications networks.

Modem

The abbreviation for MODULATOR and DEMODULATOR. A unit that changes a signal (without losing the information content) to make it more suitable for transmission over a particular medium. For example modems are used to convert digital computer signals to analogue tones for transmission over PSTN lines (and convert tones back to digital signals at the end of a link).

Multiplexer (MUX)

Device that combines a number of signal channels onto one link.

Private Automatic Branch Exchange (PABX)

A privately operated switching system (telephone exchange) that provides for internal connections and for connections to external (usually PSTN) exchange lines. Normally includes an operator position.

Packet switching

A system whereby packets of data of a set size and format can be transmitted in a network. The network is open to all users at all times and the packets carry their own control instructions. A CCITT standard for packet switched networks is termed X25.

Packet Switched Data Network (PSDN)

A private or public data network which conforms to CCITT Recommendation X.25.

Public Switched Telephone Network (PSTN)**Post, Telephone and Telegraph (PTT)**

An old term that used to refer to the Government bodies that ran the national communications networks (e.g. G.P.O.) and now used to refer to the primary supplier of telecommunications services in a country.

Port

The entrance or physical access point to a repeater, computer, multiplexer, telecom device or network where signals may be supplied, extracted or observed.

Propagation delay

The time it takes for a signal to travel between two points in a circuit or network.



Protocol

A set of rules and conventions for communicating over a network. The use of standard protocols allows products from multiple vendors to communicate on a common network.

Synchronous transmission/Synchronous digital hierarchy (SDH)

A class of data transmission whereby each requester is preallocated a maximum bandwidth and guaranteed a response time not to exceed a specific delay.

Radio paging

A network radio system that employs small radio units that are carried by users. Simple units can be made to emit an audio tone by making a telephone call. More sophisticated units can receive short messages in text form.

Time Division Multiplex. (TDM)

The division of information being transmitted in a channel to increase transmission capacity.

Telemetry

The transmission of control and data signals over communications links.

Topology

A graphical map of the communications network, describing how it is configured and how the transmissions flow.

Transmission

The method of movement of data, in networks this occurs in two basic formats.

Parallel Transmission: Sends each bit separately over a dedicated line; thus to send an 8 bit signal you require 8 core cable. This permits fast transmission.

Serial Transmission: Sends one bit at a time and is slower.

Unbalanced line

A cable or other type of transmission line connected such that the amplitudes of the voltages on the conductors are not equal or opposite with respect to ground. Usually wired with one conductor connected to ground (e.g. a coaxial cable).

Wavelength

A measurement of the length of any electromagnetic wave. The shorter the wavelength, the higher the frequency.

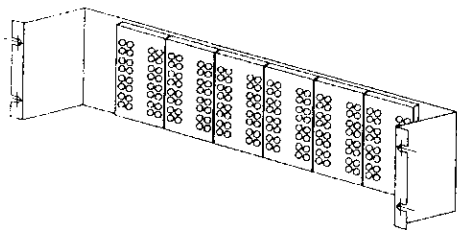

Panel for use in standard IEC 297, 19" racks.
Accommodates up to 6 by 32 connectors.

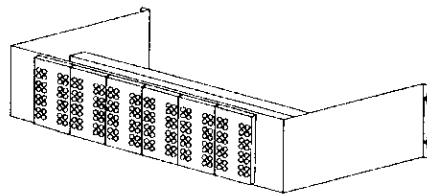

Panel for use in communication industry racks.
Accommodates up to 6 by 32 connectors.

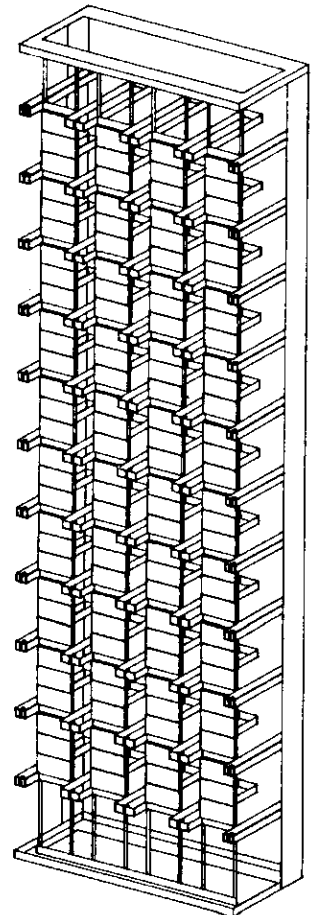

For further details please contact your RADIALL sales representative.

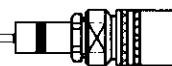

Cross References by Industry/Transradio/Radiall Part Nos.

Industry (BT) Reference	Transradio Single Pack	Transradio MultiPack	Radiall Ref. Single Pack	Radiall Ref. MultiPack	Cable Group
P43/1G	Q96235Z	Q96134Z	R214 311 740	R214 311 744	2001
P43/2G	Q96236Z	Q96135Z	R214 311 760	R214 311 764	2002
P43/3G	Q96237Z	Q96136Z	R214 311 780	R214 311 784	2003
P43/4G	Q96273Z	Q96155Z	R214 311 700	R214 311 704	RG179
P43/5G	Q96242Z	Q96137Z	R214 311 720	R214 311 724	3002/TZC75024
P43/1GTI	Q96258Z	Q96100Z	R214 312 740	R214 312 744	2001
P43/2GTI	Q96259Z	Q96101Z	R214 312 760	R214 312 764	2002
P43/3GTI	Q96260Z	Q96102Z	R214 312 780	R214 312 784	2003
P43/4GTI	Q96294Z	Q96133Z	R214 312 700	R214 312 704	RG179
P43/5GTI	Q96261Z	Q96103Z	R214 312 720	R214 312 724	3002/TZC75024
P43/1GTIS	Not applicable	Q96114Z	Not applicable	R214 313 742	2001
P43/2GTIS	Not applicable	Q96115Z	Not applicable	R214 313 762	2002
P43/3GTIS	Not applicable	Q96116Z	Not applicable	R214 313 782	2003
P43/4GTIS	Not applicable	Q96140Z	Not applicable	R214 313 702	RG179
P43/5GTIS	Not applicable	Q96117Z	Not applicable	R214 313 722	3002/TZC75024
P43/1F	Q96251Z	Not applicable	R214 314 740	Not applicable	2001
P43/2F	Q96252Z	Not applicable	R214 314 760	Not applicable	2002
P43/3F	Q96253Z	Not applicable	R214 314 780	Not applicable	2003
P43/4F	Q96266Z	Not applicable	R214 314 700	Not applicable	RG179
P43/5F	Q96254Z	Not applicable	R214 314 720	Not applicable	3002/TZC75024
U - LINK 13A	Q96234Z	Q96112Z	R214 790 700	R214 790 703	Not applicable
U - LINK 13B	Q96264Z	Q96113Z	R214 791 700	R214 791 703	Not applicable
S43/1F	Q96238Z	Q96104Z	R214 082 940	R214 082 944	2001
S43/2F	Q96239Z	Q96105Z	R214 082 960	R214 082 964	2002
S43/3F	Q96240Z	Q96106Z	R214 082 980	R214 082 984	2003
S43/4F	Q96291Z	Q96134Z	R214 082 900	R214 082 904	RG179
S43/5F	Q96241Z	Q96107Z	R214 082 920	R214 082 924	3002/TZC75024
S43/1FS	Not applicable	Q96118Z	Not applicable	R214 083 942	2001
S43/2FS	Not applicable	Q96119Z	Not applicable	R214 083 962	2002
S43/3FS	Not applicable	Q96120Z	Not applicable	R214 083 982	2003
S43/4FS	Not applicable	Q96141Z	Not applicable	R214 083 902	RG179
S43/5FS	Not applicable	Q96121Z	Not applicable	R214 083 922	3002/TZC75024
S43/1C	Q96224Z	Q96108Z	R214 182 940	R214 182 942	2001
S43/2C	Q96225Z	Q96109Z	R214 182 960	R214 182 962	2002
S43/3C	Q96226Z	Q96110Z	R214 182 980	R214 182 982	2003
S43/4C	Q96227Z	Q96142Z	R214 182 900	R214 182 902	RG179
S43/5C	Q96256Z	Q96111Z	R214 182 920	R214 182 922	3002/TZC75024
HDCP43/1GTI	Q96274Z	Q96124Z	R214 317 740	R214 317 744	2001
HDCP43/3GTI	Q96276Z	Q96126Z	R214 317 780	R214 317 784	2003
HDCP43/4GTI	Q962104Z	Q96138Z	R214 317 700	R214 317 704	RG179
HDCP43/5GTI	Q96262Z	Q96127Z	R214 317 720	R214 317 724	3002/TZC75024
HDCP43/1GTIS	Not applicable	Q96145Z	Not applicable	R214 318 742	2001
HDCP43/2GTIS	Not applicable	Q96146Z	Not applicable	R214 318 762	2002
HDCP43/3GTIS	Not applicable	Q96147Z	Not applicable	R214 318 782	2003

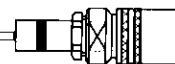

Cross References by Industry/Transradio/Radiall Part Nos.

Industry (BT) Reference	Transradio Single Pack	Transradio Multipack	Radiall Ref. Single Pack	Radiall Ref. Multipack	Cable Group
HDCP43/4GTIS	Not applicable	Q96148Z	Not applicable	R214 318 702	RG179
HDCP43/5GTIS	Not applicable	Q96149Z	Not applicable	R214 318 722	3002/TZC75024
U - LINK 10A	Q96275Z	Q96122Z	R214 797 700	R214 797 703	Not applicable
U - LINK 10B	Q96263Z	Q96123Z	R214 798 700	R214 798 703	Not applicable
HDCS43/1F	Q96287Z	Q96128Z	R214 087 940	R214 087 944	2001
HDCS43/2F	Q96288Z	Q96129Z	R214 087 960	R214 087 964	2002
HDCS43/3F	Q96289Z	Q96130Z	R214 087 980	R214 087 984	2003
HDCS43/4F	Q962105Z	Q96139Z	R214 087 900	R214 087 904	RG179
HDCS43/5F	Q96286Z	Q96131Z	R214 087 920	R214 087 924	3002/TZC75024
HDCS43/1FS	Not applicable	Q96150Z	Not applicable	R214 088 942	2001
HDCS43/2FS	Not applicable	Q96151Z	Not applicable	R214 088 962	2002
HDCS43/3FS	Not applicable	Q96152Z	Not applicable	R214 088 982	2003
HDCS43/4FS	Not applicable	Q96153Z	Not applicable	R214 088 902	RG179
HDCS43/5FS	Not applicable	Q96154Z	Not applicable	R214 088 922	3002/TZC75024
P43/1D	Q96232Z	Not applicable	R214 426 700	R214 426 704	Not applicable
P43/1E	Q96233Z	Not applicable	R214 665 700	R214 665 704	Not applicable
P43 TO BNC PLUG ADAPTER	Q980106Z	Not applicable	R192 486 000	Not applicable	Not applicable
UHDCP43/5GTIS	Not applicable	Q96157Z	Not applicable	R214 320 722	3002/TZC75024
UHDCP43/5FS	Not applicable	Q96158Z	Not applicable	R214 089 922	3002/TZC75024
BNC, STRAIGHT FULL CRIMP, PLUG	Q937215Z	Q937230Z	R142 083 320	R142 083 330	2002
BNC, STRAIGHT FULL CRIMP, PLUG	Q937220Z	Q937231Z	R142 086 320	R142 086 340	2003
BNC, STRAIGHT FULL CRIMP, PLUG	Not applicable	Not applicable	R142 076 000	R142 076 170	RG179
BNC, STRAIGHT FULL CRIMP, PLUG	Q937217Z	Q937232Z	R142 081 120	R142 081 130	3002/TZC75024
BNC, R/ANGLE SOL- DER CRIMP, PLUG	Q937227A	Q937236A	R142 181 200W	R142 181 200	2002
BNC, R/ANGLE SOL- DER CRIMP, PLUG	Q937228A	Q937237A	R142 185 200W	R142 185 200	2003
BNC, R/ANGLE SOL- DER CRIMP, PLUG	Q937229A	Q937238A	R142 177 200W	R142 177 200	3002/TZC75024
BNC, STRAIGHT CRIMP B/HEAD JACK	Q937225A	Q937233A	CONSULT FACTORY	CONSULT FACTORY	2002
BNC, STRAIGHT CRIMP B/HEAD JACK	Q937221A	Q937234A	CONSULT FACTORY	CONSULT FACTORY	2003
BNC, STRAIGHT CRIMP B/HEAD JACK	Not applicable	Not applicable	R142 331 011	R142 331 020	RG179
BNC, STRAIGHT CRIMP B/HEAD JACK	Q937226A	Q937235A	R142 325 100W	R142 325 106	3002/TZC75024
SMB, R/ANGLE, SOL- DER CRIMP PLUG	Not applicable	Not applicable	R114 186 100	Not applicable	RG179
SMB, R/ANGLE, SOL- DER CRIMP PLUG	Not applicable	Not applicable	R114 191 300	Not applicable	3002/TZC75024



RADIALL Part Numbers	Page	RADIALL Part Numbers	Page	RADIALL Part Numbers	Page	RADIALL Part Numbers	Page
R114 186 100	28	R214 083 902	17	R214 311 740	15	R214 317 784	21
R114 191 300	28	R214 083 922	17	R214 311 744	15	R214 318 702	21
R142 076 000	26	R214 083 942	17	R214 311 760	15	R214 318 722	21
R142 076 170	26	R214 083 962	17	R214 311 764	15	R214 318 742	21
R142 081 120	26	R214 083 982	17	R214 311 780	15	R214 318 762	21
R142 081 130	26	R214 087 900	22	R214 311 784	15	R214 318 782	21
R142 081 320	26	R214 087 904	22	R214 312 700	16	R214 320 722	24
R142 081 330	26	R214 087 920	22	R214 312 704	16	R214 426 700	19
R142 083 320	26	R214 087 924	22	R214 312 720	16	R214 426 704	19
R142 083 330	26	R214 087 940	22	R214 312 724	16	R214 665 700	20
R142 086 320	26	R214 087 944	22	R214 312 740	16	R214 665 704	20
R142 086 340	26	R214 087 960	22	R214 312 744	16	R214 721 703	27
R142 177 200	26	R214 087 964	22	R214 312 760	16	R214 790 700	18
R142 177 200W	26	R214 087 980	22	R214 312 764	16	R214 790 703	18
R142 181 200	26	R214 087 984	22	R214 312 780	16	R214 791 700	19
R142 181 200W	26	R214 088 902	22	R214 312 784	16	R214 791 703	19
R142 185 200	26	R214 088 922	22	R214 313 702	15	R214 797 700	23
R142 185 200W	26	R214 088 942	22	R214 313 722	15	R214 797 703	23
R142 325 100W	27	R214 088 962	22	R214 313 742	15	R214 797 721	25
R142 325 106	27	R214 088 982	22	R214 313 762	15	R214 797 723	25
R142 331 011	27	R214 089 922	24	R214 313 782	15	R214 798 700	23
R142 331 020	27	R214 182 900	19	R214 314 700	16	R214 798 703	23
R192 486 000	27	R214 182 902	19	R214 314 720	16	R214 798 721	25
R192 489 500	27	R214 182 920	19	R214 314 740	16	R214 798 723	25
R214 082 900	17	R214 182 922	19	R214 314 760	16	R282 079 000	29
R214 082 904	17	R214 182 940	19	R214 314 780	16	R282 127 000	29
R214 082 920	17	R214 182 942	19	R214 317 700	21	R282 201 010	29
R214 082 924	17	R214 182 960	19	R214 317 704	21	R282 265 001	29
R214 082 940	17	R214 182 962	19	R214 317 720	21	R282 265 002	29
R214 082 944	17	R214 182 980	19	R214 317 724	21	R282 265 003	29
R214 082 960	17	R214 182 982	19	R214 317 740	21	R282 265 004	29
R214 082 964	17	R214 311 700	15	R214 317 744	21	R282 281 010	29
R214 082 980	17	R214 311 704	15	R214 317 760	21	R282 287 000	29
R214 082 984	17	R214 311 720	15	R214 317 764	21	R282 320 000	29
		R214 311 724	15	R214 317 780	21	R282 868 201	29

RADIALL PRODUCT RANGE

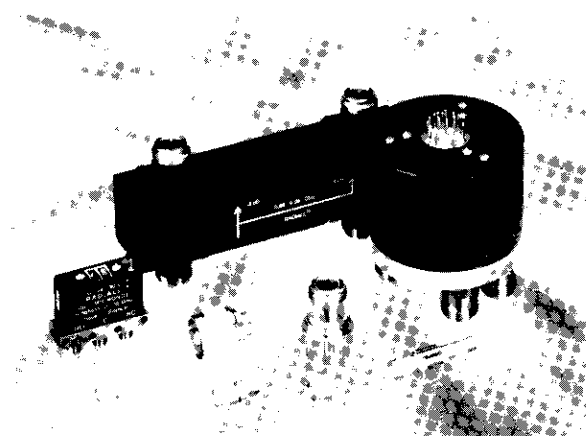

MICROWAVE COMPONENTS

- Coaxial terminations
- Coaxial attenuators
- Coaxial couplers
- Coaxial switches & waveguide
- Detectors
- Other coaxial components

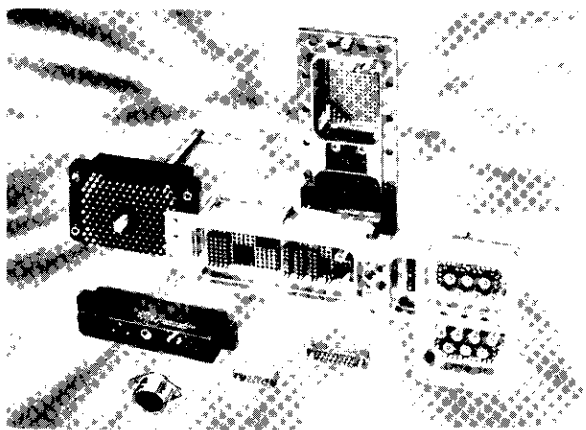

MULTICONNECT CONTACTORS

- Rack & panel rectangular connectors
- Miniature & subminiature rectangular connectors
- Cylindrical connectors
- Professional banana plugs, sockets and cable assemblies
- Customized connectors



FIBER OPTIC COMPONENTS

- Singlemode & multimode fiber optic connectors :
EC, high performances connectors, "push-pull" latching system
FC
SC
ST*
FSMA
OPTABALL VFO / PFO / MFO / MP
OPTIPACK & BPO, back plane connectors
FOTAC & BOC : ruggedized hermaphroditic multiway connectors

ST* is a registered trade mark of AT & T

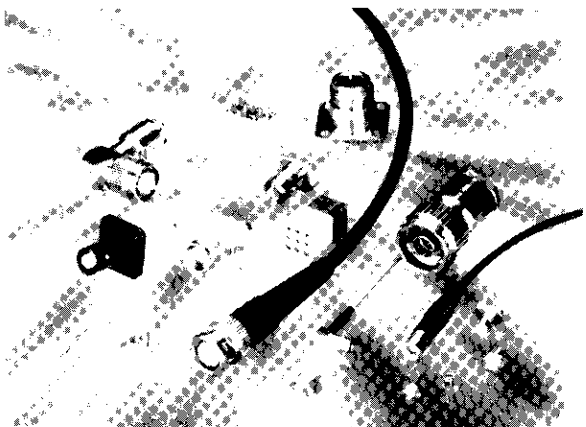

COAXIAL CONNECTORS DC - 46 GHz

- Microminiature & subminiature
- Miniature
- Standard
- Special
- High voltage
- Between series adaptors
- Accessories & assembly tooling
- RF cable assemblies
Low loss high frequency coaxial cable assemblies.